

25.0Amps. Glass Passivated Power Rectifiers

Description

Mechanical Dimensions

FG2501~2507

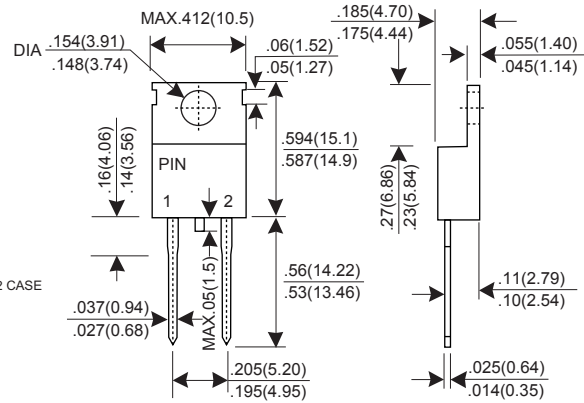
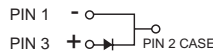

Dimensions in inches and (millimeters)

TO-220AC

Features

- ✧ Low forward voltage drop
- ✧ High current capability
- ✧ High reliability
- ✧ High surge current capability
- ✧ Weight: 2.24 grams

Mechanical Data

- ✧ Cases: TO-220AC molded plastic
- ✧ Epoxy: UL 94V-0 rate flame retardant
- ✧ Terminals: Leads solderable per MIL-STD-202, Method 208 guaranteed
- ✧ Polarity: As marked
- ✧ High temperature soldering guaranteed: 260°C/10 seconds .16", (4.06mm) from case

Maximum Ratings and Electrical Characteristics

Rating at 25°C ambient temperature unless otherwise specified.

Single phase, half wave, 60 Hz, resistive or inductive load.

For capacitive load, derate current by 20%

Type Number	Symbol	FG	FG	FG	FG	FG	FG	FG	Units
		2501	2502	2503	2504	2505	2506	2507	
Maximum Recurrent Peak Reverse Voltage	V_{RRM}	50	100	200	400	600	800	1000	V
Maximum RMS Voltage	V_{RMS}	35	70	140	280	420	560	700	V
Maximum DC Blocking Voltage	V_{DC}	50	100	200	400	600	800	1000	V
Maximum Average Forward Rectified Current .375"(9.5mm) Lead Length @ $T_C = 100^\circ C$	$I_{(AV)}$	25.0							A
Peak Forward Surge Current, 8.3 ms Single Half Sine-wave Superimposed on Rated Load (JEDEC method)	I_{FSM}	400							A
Maximum Instantaneous Forward Voltage @ 25A	V_F	1.1							V
Maximum DC Reverse Current @ $T_C=25^\circ C$ at Rated DC Blocking Voltage	I_R	10							uA uA
Typical Junction Capacitance (Note 1)	C_j	100							pF
Typical Thermal Resistance (Note 2)	$R\theta_{JC}$	2.3							C/W
Operating and Storage Temperature Range	T_J, T_{STG}	- 65 to + 175							C/W

Notes: 1. Measured at 1 MHz and Applied Reverse Voltage of 4.0 Volts D.C.

2. Thermal Resistance from Junction to Case Mounted on Heatsink size 2" x 3" x 0.25" Al-Plate



25.0Amps. Glass Passivated Power Rectifiers

RATINGS AND CHARACTERISTIC CURVES (FG2501G THRU FG2507G)

FIG.1- MAXIMUM FORWARD CURRENT DERATING CURVE

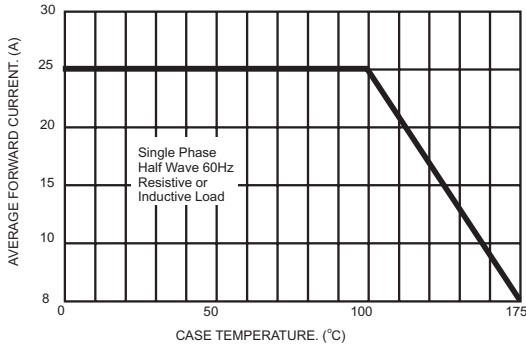

FIG.2- MAXIMUM NON-REPETITIVE FORWARD SURGE CURRENT

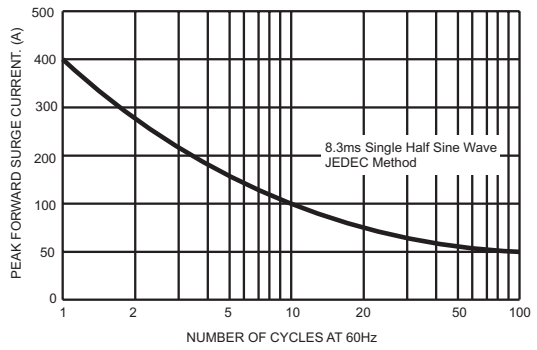

FIG.3- TYPICAL INSTANTANEOUS FORWARD CHARACTERISTICS

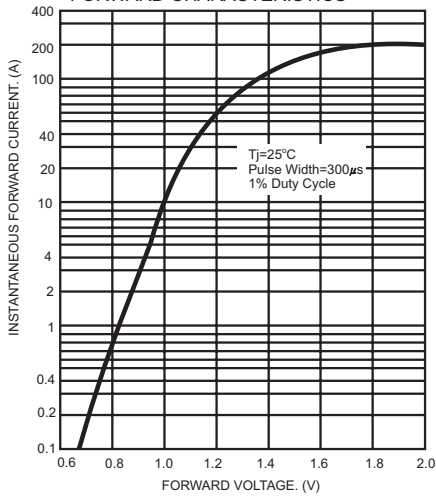

FIG.4- TYPICAL REVERSE CHARACTERISTICS

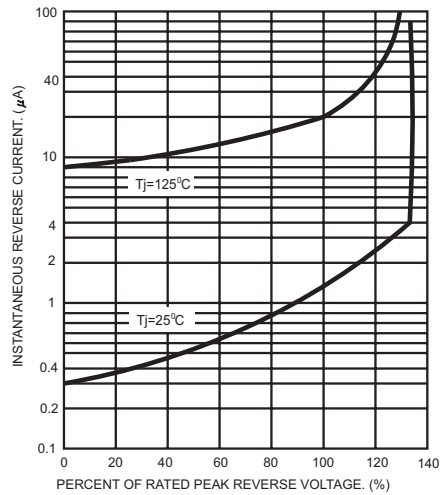
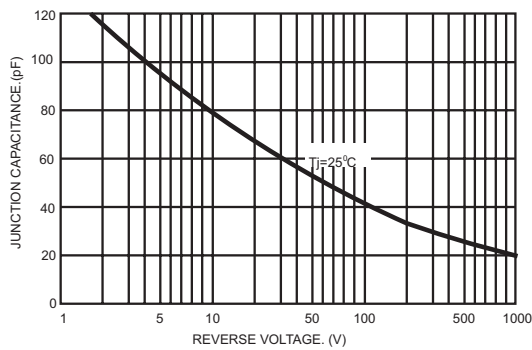

FIG.5- TYPICAL JUNCTION CAPACITANCE



FG2501~2507