

The UC3844A series of high performance fixed frequency current mode controllers are specifically designed for off-line and dc-to-dc converter applications offering the designer a cost effective solution with minimal external components. This integrated circuit features an oscillator, a temperature compensated reference, high gain error amplifier, current sensing comparator, and a high current totem pole output ideally suited for driving a power MOSFET.

Also included are protective features consisting of input and reference undervoltage lockouts each with hysteresis, cycle-by-cycle current limiting,

- Output Deadtime Adjustable from 50% to 70%
- Current Mode Operation to 500 kHz
- Automatic Feed Forward Compensation
- Latching PWM for Cycle-By-Cycle Current Limiting
- Internally Trimmed Reference with Undervoltage Lockout
- High Current Totem Pole Output
- Undervoltage Lockout with Hysteresis
- Low Startup and Operating Current

a latch for single pulse metering, and a flip-flop which blanks the output off every other oscillator cycle, allowing output deadtimes to be programmed for 50% to 70%.

This device is available in an 8-pin dual-in-line plastic package as well as the 14-pin plastic surface mount (SOP-14). The SOP-14 package has separate power and ground pins for the totem pole output stage.

The UC3844A has UVLO thresholds of 16V (on) and 10V (off), Ideally suited for off-line converters.

CDSUFFIX
PLASTIC PACKAGE
8 DIP



D8SUFFIX
PLASTIC PACKAGE
8 SOP



CSSUFFIX
PLASTIC PACKAGE
SOP-14



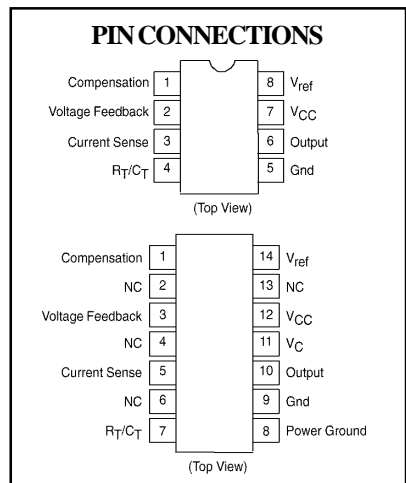
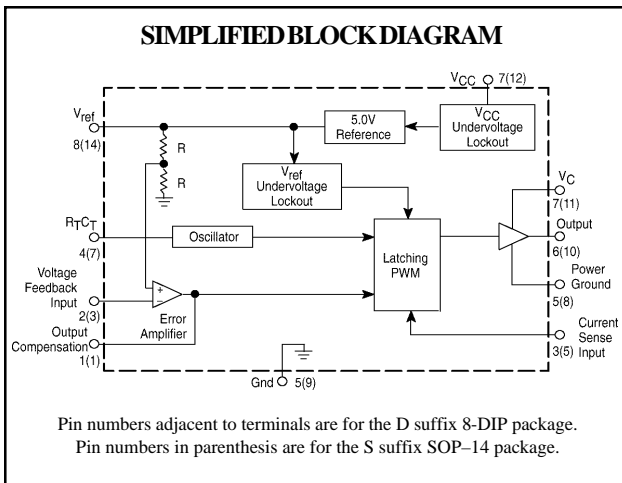

- NOTES:**
1. Maximum Package power dissipation limits must be observed.
 2. Adjust V_{CC} above the Startup threshold before setting to 15 V.
 3. Low duty cycle pulse techniques are used during test to maintain junction temperature as close to ambient as possible
 $T_{low} = 0^{\circ}C$, $T_{high} = +70^{\circ}C$.
 4. This parameter is measured at the latch trip point with $V_{FB} = 0V$.
 5. Comparator gain is defined as: $A_v = \frac{\Delta V \text{ Output Compensation}}{\Delta V \text{ Current Sense Input}}$

ABSOLUTE MAXIMUM RATINGS

Item	Symbol	Rating	Unit
Total Power Supply and Zener Current	$(I_{CC} + I_Z)$	30	mA
Output Current, Source or Sink (Note 1)	I_O	1.0	A
Output Energy (Capacitive Load per Cycle)	W	5.0	μ J
Current Sense and Voltage Feedback Inputs	V_{in}	-0.3 to +5.5	V
Error Amp Output Sink Current	I_O	10	mA
Power Dissipation and Thermal Characteristics CS, D8 Suffix, SOP-14, SOP-8 Package	P_D	862	mW
Maximum Power Dissipation	$R_{\theta JA}$	145	$^{\circ}$ C/W
Thermal Resistance, Junction to Air			
CD Suffix, 8-DIP Package	P_D	1.25	W
Maximum Power Dissipation	$R_{\theta JA}$	100	$^{\circ}$ C/W
Thermal Resistance, Junction to Air			
Operating Ambient Temperature Range	T_A	0 to 70	$^{\circ}$ C
Operating Junction Temperature	T_J	150	$^{\circ}$ C
Storage Temperature Range	T_S	-65 to 150	$^{\circ}$ C

ELECTRICAL CHARACTERISTICS

$V_{CC} = 15V$ (Note 2), $R_T = 10k$, $C_T = 3.3nF$, $T_A = 0$ to $70^{\circ}C$ (Note 3) unless otherwise noted.

REFERENCE SECTION

Item	Symbol	Min	Typ	Max	Unit
Reference Output Voltage ($I_O = 1.0mA$, $T_J = 25^{\circ}C$)	V_{REF}	4.9	5.0	5.1	V
Line Regulation ($V_{CC} = 12V$ to $25V$)	Reg_{line}	---	2.0	20	mV
Load Regulation ($I_O = 1.0mA$ to $20mA$)	Reg_{load}	---	3.0	25	mV
Temperature Stability	T_S	---	0.2	---	mV/ $^{\circ}$ C
Total Output Variation over Line, Load, Temp.	V_{REF}	4.82	---	5.18	V
Output Noise Voltage ($f = 10Hz$ to $10kHz$, $T_J = 25^{\circ}C$)	V_n	---	50	---	μ V
Long Term Stability ($T_A = 125^{\circ}C$ for 1000 Hours)	S	---	5.0	---	mV
Output Short Circuit Current	ISC	-30	-85	-180	mA

OSCILLATOR SECTION

Frequency $T_J = 25^{\circ}C$ $T_A = 0$ to $70^{\circ}C$	f_{osc}	47 46	52 ---	57 60	V
Frequency Change with Voltage ($V_{CC} = 12V$ to $25V$)	$\Delta f_{osc}/\Delta V$	---	0.2	1.0	%
Frequency Change with Temperature	$\Delta f_{osc}/\Delta T$	---	5.0	---	%
Oscillator Voltage Swing (Peak-to-Peak)	V_{osc}	---	1.6	---	V
Discharge Current ($V_{osc} = 2.0V$) $T_J = 25^{\circ}C$	I_{dischg}	---	10.8	---	mA

ELECTRICAL CHARACTERISTICS

ERROR AMPLIFIER SECTION

Item	Symbol	Min	Typ	Max	Unit
Voltage Feedback Input ($V_O = 2.5V$)	V_{FB}	2.42	2.5	2.58	V
Input Bias Current ($V_{FB} = 2.7V$)	I_{IB}	---	-0.1	-2.0	μA
Open Loop Voltage Gain ($V_O = 2.0V$ to $4.0V$)	A_{VOL}	65	90	---	dB
Unity Gain Bandwidth ($T_J = 25^\circ C$)	BW	0.7	1.0	---	MHz
Power Supply Rejection Ratio ($V_{CC} = 12V$ to $25V$)	PSRR	60	70	---	dB
Output Current					mA
Sink ($V_O = 1.1V$, $V_{FB} = 2.7V$)	I_{Sink}	2.0	12	---	
Source ($V_O = 5.0V$, $V_{FB} = 2.3V$)	I_{Source}	-0.5	-1.0	---	
Output Voltage Swing					V
High State ($R_L = 15k$ to GND, $V_{FB} = 2.3V$)	V_{OH}	5.0	6.2	---	
Low State ($R_L = 15k$ to V_{REF} , $V_{FB} = 2.3V$)	V_{OL}	---	0.8	1.1	

CURRENT SENSE SECTION

Current Sense Input Voltage Gain (Notes 4 & 5)	A_V	2.85	3.0	3.15	V/V
Maximum Current Sense Input Threshold (Note 4)	V_{TH}	0.9	1.0	1.1	V
Power Supply Rejection Ratio ($V_{CC} = 12V$ to $25V$)	PSRR	---	70	---	dB
Input Bias Current	I_{IB}	---	-2.0	-10	μA
Propagation Delay (Current Sense Input to Output)	$t_{PLH(in/out)}$	---	150	300	ns

OUTPUT SECTION

Output Voltage					V
Low State ($I_{Sink} = 20mA$)	V_{OL}	---	0.1	0.4	
($I_{Sink} = 200mA$)		---	1.6	2.2	
High State ($I_{Sink} = 20mA$)	V_{OH}	13	13.5	---	
($I_{Sink} = 200mA$)		12	13.4	---	
Output Voltage with UVLO Activated ($V_{CC} = 6.0V$, $I_{Sink} = 1.0mA$)	$V_{OL(UVLO)}$	---	0.1	1.1	V
Output Voltage Rise Time ($C_L = 1.0nF$, $T_J = 25^\circ C$)	t_r	---	50	150	ns
Output Voltage Fall Time ($C_L = 1.0nF$, $T_J = 25^\circ C$)	t_f	---	50	150	ns

UNDERVOLTAGE LOCKOUT SECTION

Startup Threshold	V_{th}	14.5	16	17.5	V
Minimum Operating Voltage After Turn-On	$V_{CC(min)}$	8.5	10	11.5	V

PWM SECTION

Duty Cycle	Max.	DC_{max}	47	48	50	%
	Min.	DC_{min}	---	---	0	

TOTAL DEVICE

Power Supply Current ($V_{CC} = 14V$) (Note 2)	I_{CC}				mA
Startup		---	0.17	0.3	
Operating		---	12	17	
Power Supply Zener Voltage	V_Z	30	36	---	V

FIGURE 1 - TIMING RESISTOR versus OSCILLATOR FREQUENCY

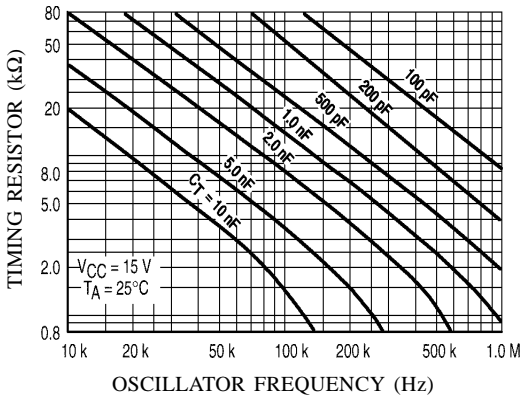

FIGURE 2 - OUTPUT DEADTIME versus OSCILLATOR FREQUENCY

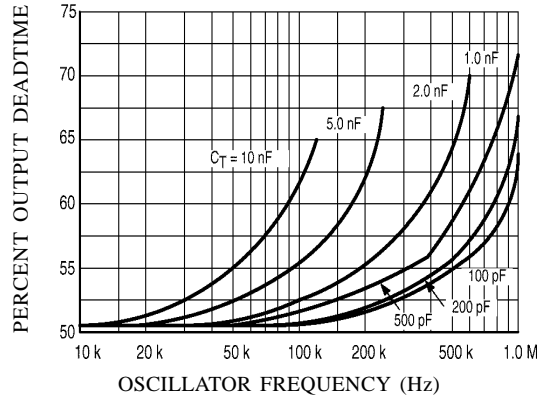

FIGURE 3 - ERROR AMP SMALL SIGNAL TRANSIENT RESPONSE

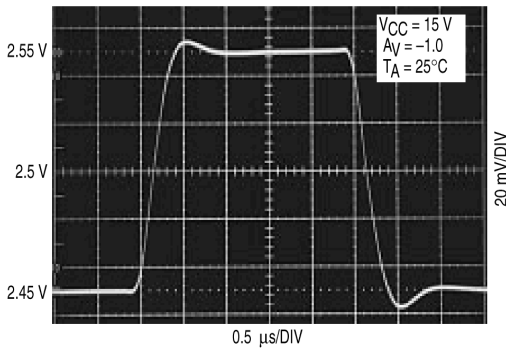

FIGURE 4 - ERROR AMP LARGE SIGNAL TRANSIENT RESPONSE

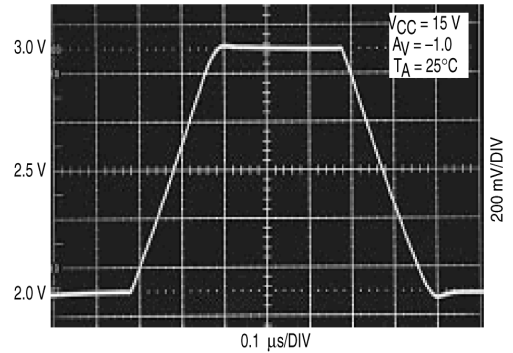

FIGURE 5 - ERROR AMP OPEN-LOOP GAIN AND PHASE versus FREQUENCY

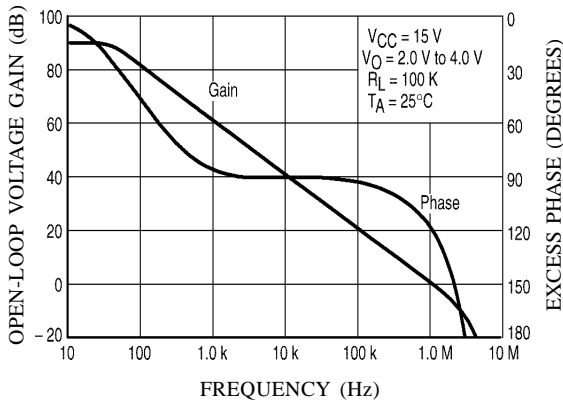

FIGURE 6 - CURRENT SENSE INPUT THRESHOLD versus ERROR AMP OUTPUT VOLTAGE

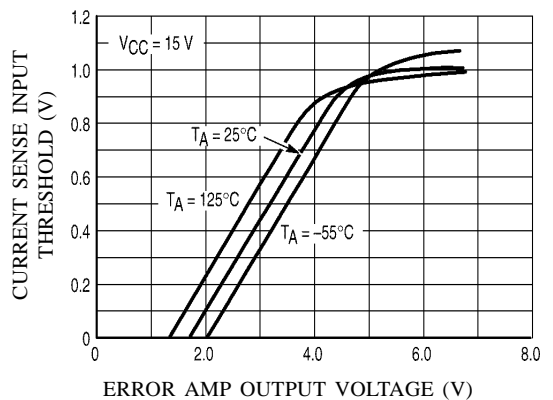

FIGURE 7 - REFERENCE VOLTAGE CHANGE versus SOURCE CURRENT

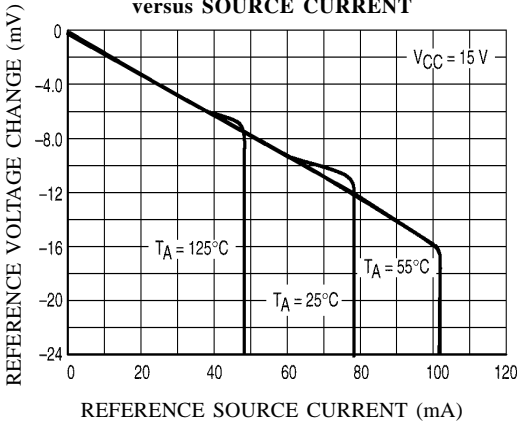

FIGURE 8 - REFERENCE SHORT CIRCUIT CURRENT versus TEMPERATURE

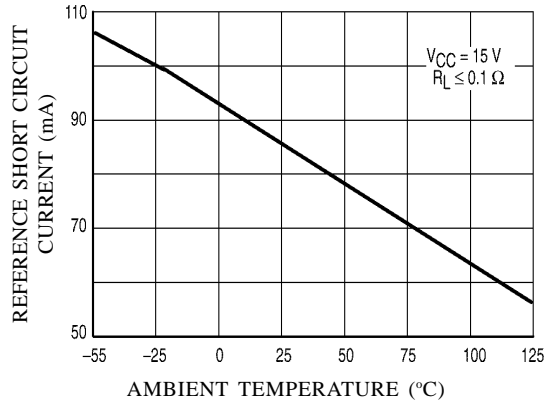

FIGURE 9 - REFERENCE LOAD REGULATION

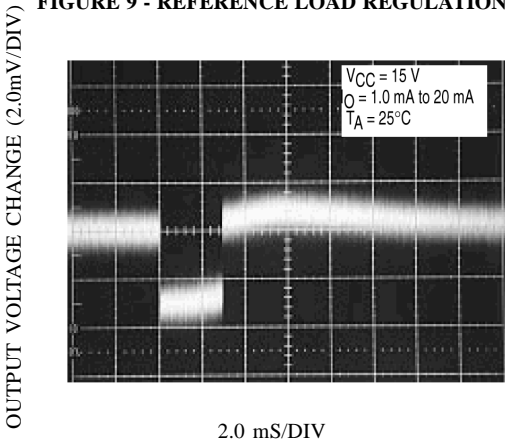

FIGURE 10 - REFERENCE LINE REGULATION

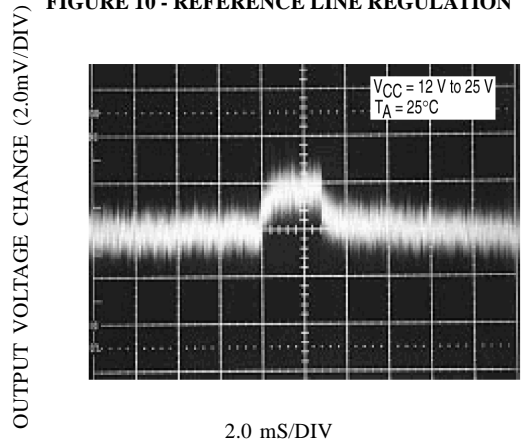

FIGURE 11 - OUTPUT SATURATION VOLTAGE versus LOAD CURRENT

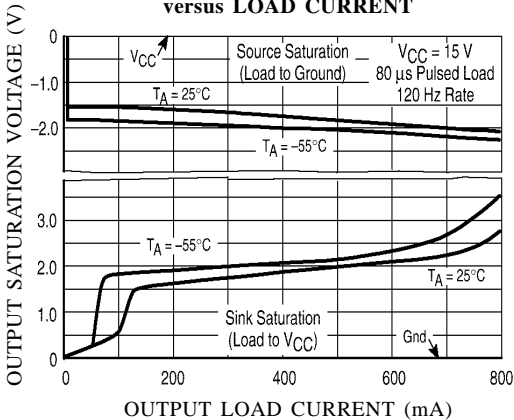

FIGURE 12 - OUTPUT WAVEFORM

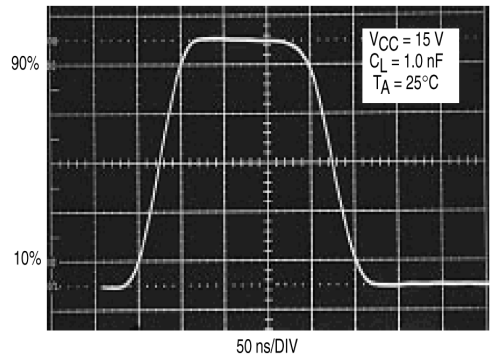

FIGURE 13 - OUTPUT CROSS CONDUCTION

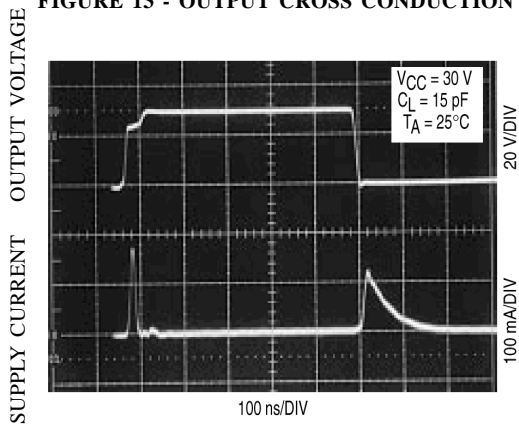

FIGURE 14 - SUPPLY CURRENT versus SUPPLY VOLTAGE

