

The UC3843A series of high performance fixed frequency current mode controllers are specifically designed for off-line and dc-to-dc converter applications offering the designer a cost effective solution with minimal external components. This integrated circuit features a trimmed oscillator for precise duty cycle control, a temperature compensated reference, high gain error amplifier, current sensing comparator, and a high current totem pole output ideally suited for driving a power MOSFET.

Also included are protective features consisting of input and reference undervoltage lockouts each with hysteresis, cycle-by-cycle current limiting, programmable output deadtime, and a latch for single pulse metering.

This device is available in an 8-pin dual-in-line plastic package as well as the 14-pin plastic surface mount (SO-14). The SO-14 package has separate power and ground pins for the totem pole output stage.

The UCX843A is tailored for lower voltage applications having UVLO thresholds of 8.5 V (on) and 7.6 V (off).

- Trimmed Oscillator Discharge Current for Precise Duty Cycle Control
- Current Mode Operation to 500 kHz
- Automatic Feed Forward Compensation
- Latching PWM for Cycle-By-Cycle Current Limiting
- Internally Trimmed Reference with Undervoltage Lockout
- High Current Totem Pole Output
- Undervoltage Lockout with Hysteresis
- Low Startup and Operating Current

**DSUFFIX**  
PLASTIC PACKAGE  
8 DIP

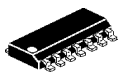
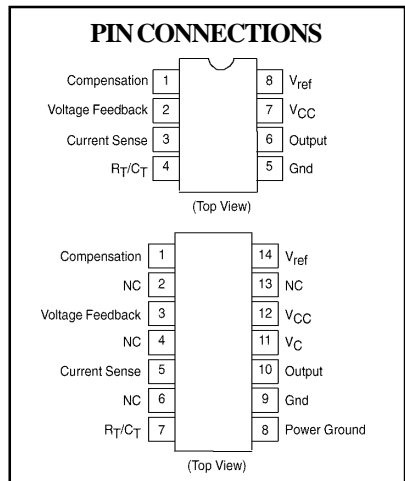
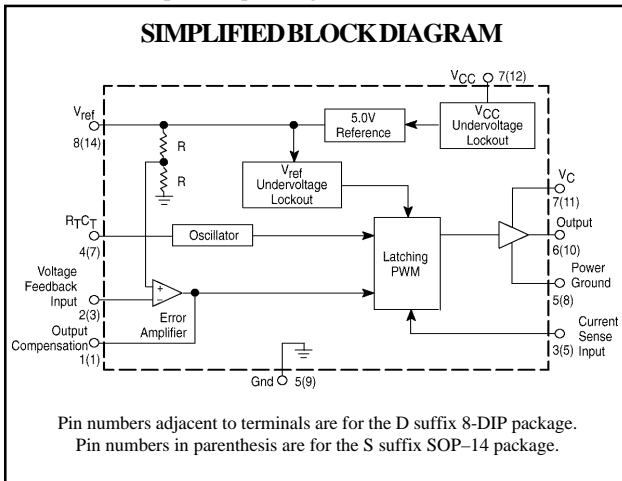

**SSUFFIX**  
PLASTIC PACKAGE  
SOP-14

- NOTES:**
1. Maximum Package power dissipation limits must be observed.
  2. Adjust V<sub>CC</sub> above the Startup threshold before setting to 15 V.
  3. Low duty cycle pulse techniques are used during test to maintain junction temperature as close to ambient as possible  
T<sub>low</sub> = 0°C, T<sub>high</sub> = +70°C.
  4. This parameter is measured at the latch trip point with V<sub>FB</sub> = 0V.
  5. Comparator gain is defined as:  $A_v = \frac{\Delta V \text{ Output Compensation}}{\Delta V \text{ Current Sense Input}}$

## ABSOLUTE MAXIMUM RATINGS

Item	Symbol	Rating	Unit
Total Power Supply and Zener Current	$(I_{CC} + I_Z)$	30	mA
Output Current, Source or Sink (Note 1)	$I_O$	1.0	A
Output Energy (Capacitive Load per Cycle)	W	5.0	$\mu$ J
Current Sense and Voltage Feedback Inputs	$V_{in}$	-0.3 to +5.5	V
Error Amp Output Sink Current	$I_O$	10	mA
Power Dissipation and Thermal Characteristics			
S Suffix, SOP-14 Package			
Maximum Power Dissipation	$P_D$	862	mW
Thermal Resistance, Junction to Air	$R_{\theta JA}$	145	$^{\circ}$ C/W
D Suffix, 8-DIP Package			
Maximum Power Dissipation	$P_D$	1.25	W
Thermal Resistance, Junction to Air	$R_{\theta JA}$	100	$^{\circ}$ C/W
Operating Ambient Temperature Range	$T_A$	0 to 70	$^{\circ}$ C
Operating Junction Temperature	$T_J$	150	$^{\circ}$ C
Storage Temperature Range	$T_S$	-65 to 150	$^{\circ}$ C

## ELECTRICAL CHARACTERISTICS

$V_{CC} = 15V$  (Note 2),  $R_T = 10k$ ,  $C_T = 3.3nF$ ,  $T_A = 0$  to  $70^{\circ}C$  (Note 3) unless otherwise noted.

### REFERENCE SECTION

Item	Symbol	Min	Typ	Max	Unit
Reference Output Voltage ( $I_O = 1.0mA$ , $T_J = 25^{\circ}C$ )	$V_{REF}$	4.9	5.0	5.1	V
Line Regulation ( $V_{CC} = 12V$ to $25V$ )	$Reg_{line}$	---	2.0	20	mV
Load Regulation ( $I_O = 1.0mA$ to $20mA$ )	$Reg_{load}$	---	3.0	25	mV
Temperature Stability	$T_S$	---	0.2	---	mV/ $^{\circ}$ C
Total Output Variation over Line, Load, Temp.	$V_{REF}$	4.82	---	5.18	V
Output Noise Voltage ( $f = 10Hz$ to $10kHz$ , $T_J = 25^{\circ}C$ )	$V_n$	---	50	---	$\mu$ V
Long Term Stability ( $T_A = 125^{\circ}C$ for 1000 Hours)	S	---	5.0	---	mV
Output Short Circuit Current	ISC	-30	-85	-180	mA

### OSCILLATOR SECTION

Frequency	$f_{osc}$				V
$T_J = 25^{\circ}C$		47	52	57	
$T_A = 0$ to $70^{\circ}C$		46	---	60	
Frequency Change with Voltage ( $V_{CC} = 12V$ to $25V$ )	$\Delta f_{osc}/\Delta V$	---	0.2	1.0	%
Frequency Change with Temperature	$\Delta f_{osc}/\Delta T$	---	5.0	---	%
Oscillator Voltage Swing (Peak-to-Peak)	$V_{osc}$	---	1.6	---	V
Discharge Current ( $V_{osc} = 2.0V$ )	$I_{dischg}$				mA
$T_J = 25^{\circ}C$		7.5	8.4	9.3	
$T_A = 0$ to $70^{\circ}C$		7.2	---	9.5	



# UC3843A High Performance Current Mode Controller

## ELECTRICAL CHARACTERISTICS

### ERROR AMPLIFIER SECTION

Item	Symbol	Min	Typ	Max	Unit
Voltage Feedback Input ( $V_O = 2.5V$ )	$V_{FB}$	2.42	2.5	2.58	V
Input Bias Current ( $V_{FB} = 2.7V$ )	$I_{IB}$	---	-0.1	-2.0	$\mu A$
Open Loop Voltage Gain ( $V_O = 2.0V$ to $4.0V$ )	$A_{VOL}$	65	90	---	dB
Unity Gain Bandwidth ( $T_J = 25^\circ C$ )	BW	0.7	1.0	---	MHz
Power Supply Rejection Ratio ( $V_{CC} = 12V$ to $25V$ )	PSRR	60	70	---	dB
Output Current					mA
Sink ( $V_O = 1.1V$ , $V_{FB} = 2.7V$ )	$I_{Sink}$	2.0	12	---	
Source ( $V_O = 5.0V$ , $V_{FB} = 2.3V$ )	$I_{Source}$	-0.5	-1.0	---	
Output Voltage Swing					V
High State ( $R_L = 15k$ to GND, $V_{FB} = 2.3V$ )	$V_{OH}$	5.0	6.2	---	
Low State ( $R_L = 15k$ to $V_{REF}$ , $V_{FB} = 2.3V$ )	$V_{OL}$	---	0.8	1.1	

### CURRENT SENSE SECTION

Current Sense Input Voltage Gain (Notes 4 & 5)	$A_V$	2.85	3.0	3.15	V/V
Maximum Current Sense Input Threshold (Note 4)	$V_{TH}$	0.9	1.0	1.1	V
Power Supply Rejection Ratio ( $V_{CC} = 12V$ to $25V$ )	PSRR	---	70	---	dB
Input Bias Current	$I_{IB}$	---	-2.0	-10	$\mu A$
Propagation Delay (Current Sense Input to Output)	$t_{PLH(in/out)}$	---	150	300	ns

### OUTPUT SECTION

Output Voltage					V
Low State ( $I_{Sink} = 20mA$ )	$V_{OL}$	---	0.1	0.4	
( $I_{Sink} = 200mA$ )		---	1.6	2.2	
High State ( $I_{Sink} = 20mA$ )	$V_{OH}$	13	13.5	---	
( $I_{Sink} = 200mA$ )		12	13.4	---	
Output Voltage with UVLO Activated ( $V_{CC} = 6.0V$ , $I_{Sink} = 1.0mA$ )	$V_{OL(UVLO)}$	---	0.1	1.1	V
Output Voltage Rise Time ( $C_L = 1.0nF$ , $T_J = 25^\circ C$ )	$t_r$	---	50	150	ns
Output Voltage Fall Time ( $C_L = 1.0nF$ , $T_J = 25^\circ C$ )	$t_f$	---	50	150	ns

### UNDERVOLTAGE LOCKOUT SECTION

Startup Threshold	$V_{th}$	7.8	8.4	9.0	V
Minimum Operating Voltage After Turn-On	$V_{CC(min)}$	7.0	7.6	8.2	V

### PWM SECTION

Duty Cycle	Max.	$DC_{max}$	94	96	---	%
	Min.	$DC_{min}$	---	---	0	

### TOTAL DEVICE

Power Supply Current ( $V_{CC} = 6.5V$ ) (Note 2)	$I_{CC}$				mA
Startup		---	0.5	1.0	
Operating		---	12	17	
Power Supply Zener Voltage	$V_Z$	30	36	---	V

**FIGURE 1 - TIMING RESISTOR versus OSCILLATOR FREQUENCY**

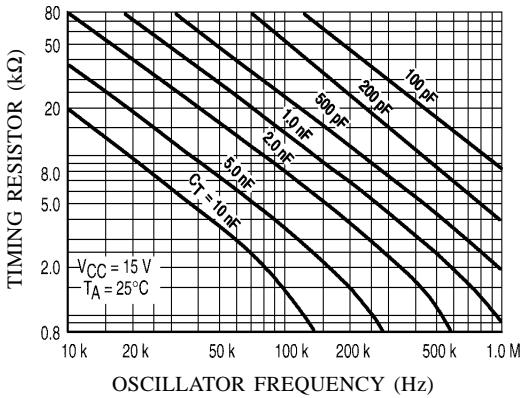

**FIGURE 2 - OUTPUT DEADTIME versus OSCILLATOR FREQUENCY**

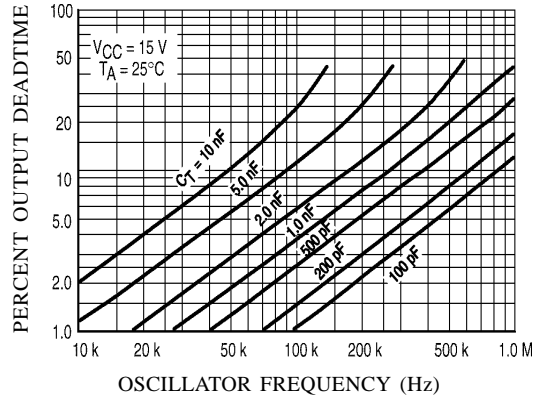

**FIGURE 3 - OSCILLATOR DISCHARGE CURRENT versus TEMPERATURE**

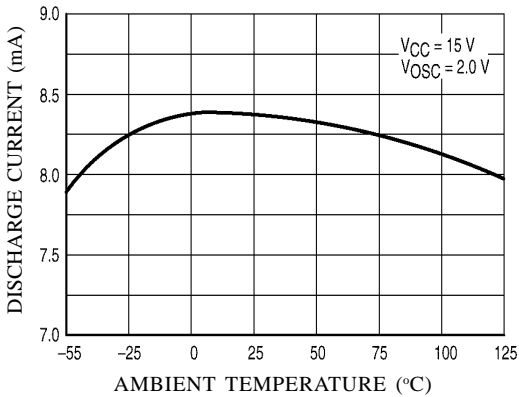

**FIGURE 4 - MAXIMUM OUTPUT DUTY CYCLE versus TIMING RESISTOR**

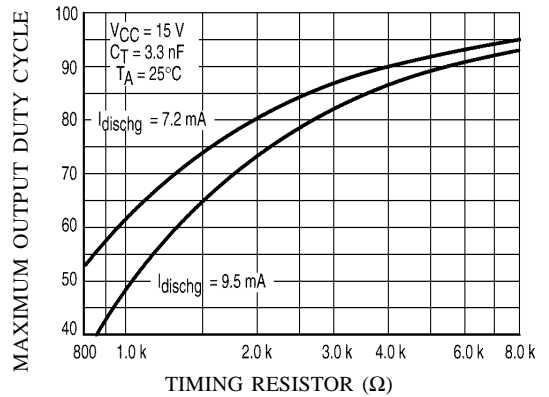

**FIGURE 5 - ERROR AMP SMALL SIGNAL TRANSIENT RESPONSE**

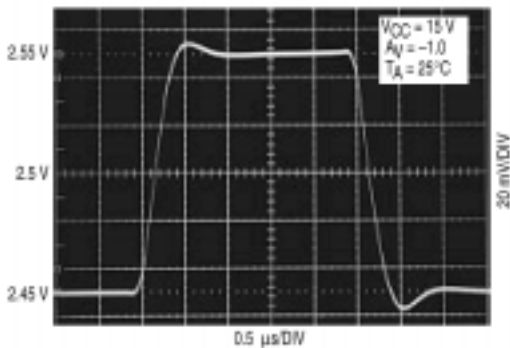

**FIGURE 6 - ERROR AMP LARGE SIGNAL TRANSIENT RESPONSE**

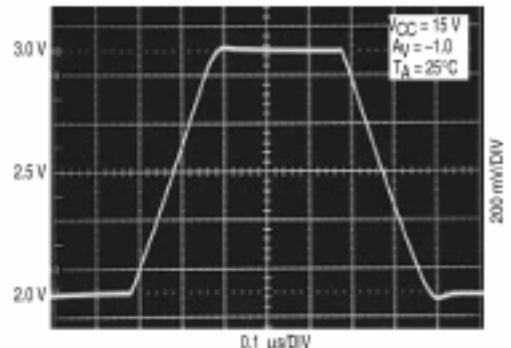

**FIGURE 7 - ERROR AMP OPEN-LOOP GAIN AND PHASE versus FREQUENCY**

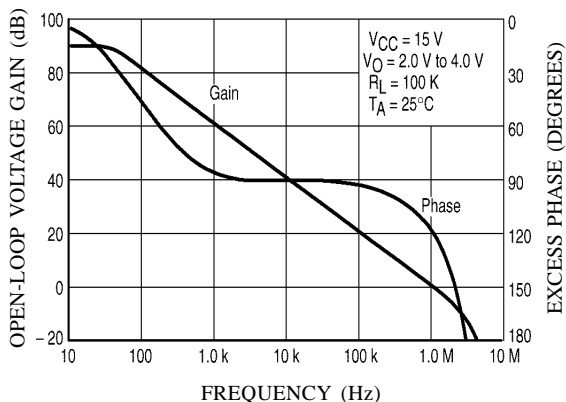

**FIGURE 8 - CURRENT SENSE INPUT THRESHOLD versus ERROR AMP OUTPUT VOLTAGE**

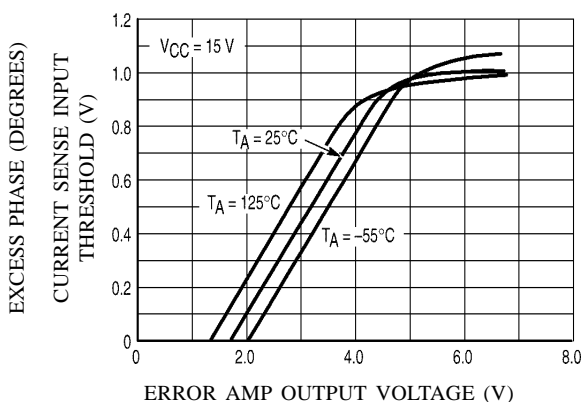

**FIGURE 9 - REFERENCE VOLTAGE CHANGE versus SOURCE CURRENT**

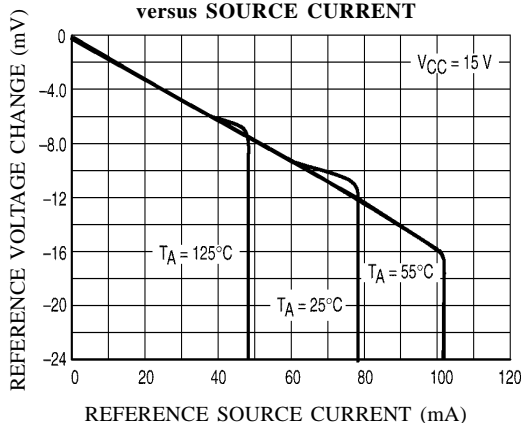

**FIGURE 10 - REFERENCE SHORT CIRCUIT CURRENT versus TEMPERATURE**

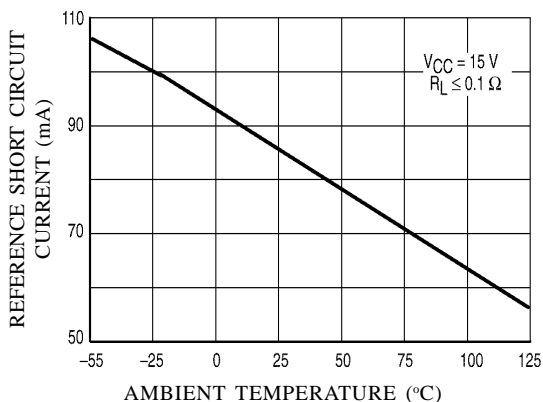

**FIGURE 11 - REFERENCE LOAD REGULATION**

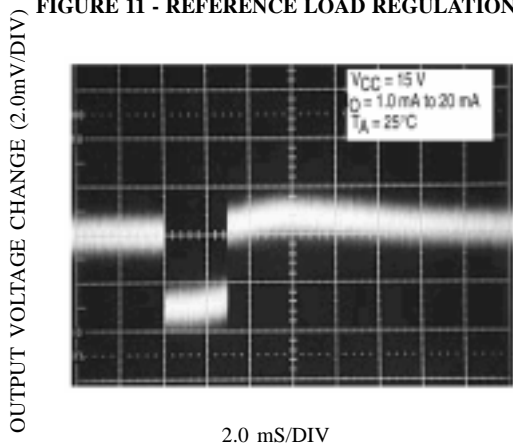

**FIGURE 12 - REFERENCE LINE REGULATION**

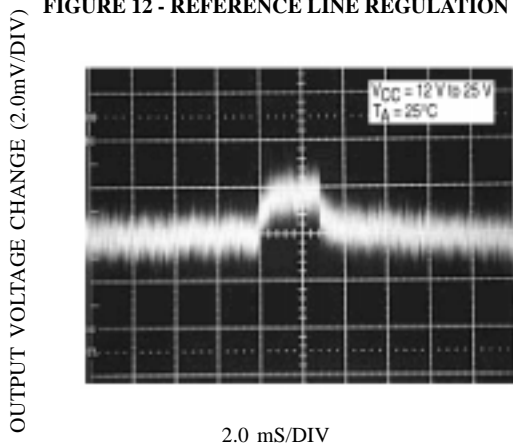

**FIGURE 13 - OUTPUT SATURATION VOLTAGE versus LOAD CURRENT**

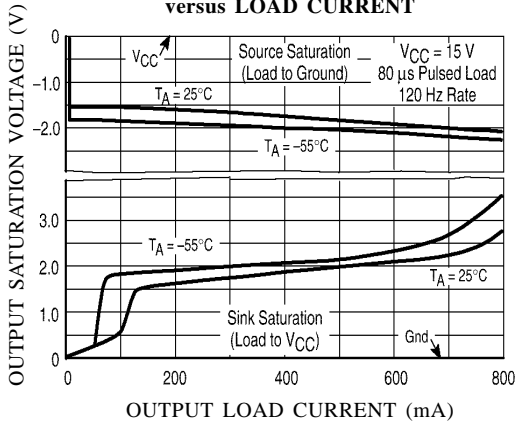

**FIGURE 14 - OUTPUT WAVEFORM**

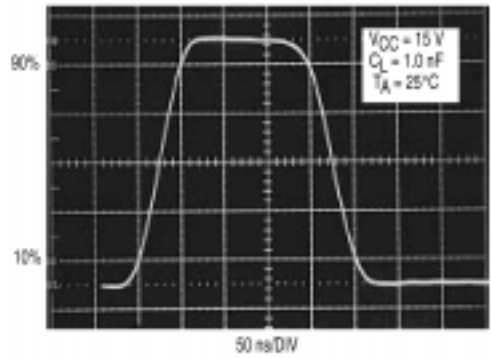

**FIGURE 15 - OUTPUT CROSS CONDUCTION**

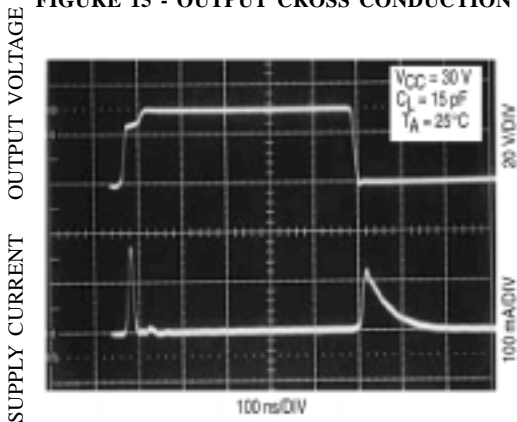

**FIGURE 16 - SUPPLY CURRENT versus SUPPLY VOLTAGE**

