

DESCRIPTION

The LT1083 series of positive adjustable regulators are designed to provide 7.5A, 5A and 3A with higher efficiency than currently available devices. All internal circuitry is designed to operate down to 1V input-to-output differential and the dropout voltage is fully specified as a function of load current. Dropout is guaranteed at a maximum of 1.5V at maximum output current, decreasing at lower load currents. On-chip trimming adjusts the reference voltage to 1%. Current limit is also trimmed, minimizing the stress on both the

regulator and power source circuitry under overload conditions.

The LT1083/LT1084/LT1085 devices are pin compatible with older three-terminal regulators. A 10 μ F output capacitor is required on these new devices. However, this is included in most regulator designs.

Unlike PNP regulators, where up to 10% of the output current is wasted as quiescent current the LT1083 quiescent current flows into the load, increasing efficiency.

- Fixed Versions Available

FEATURES

- Three-Terminal Adjustable
- Output Current of 3A, 5A 7.5A
- Operates Down to 1V Dropout
- Guaranteed Dropout Voltage at Multiple Current Levels
- Line Regulation: 0.015%
- Load Regulation: 0.01%
- 100% Thermal Limit Functional Test

APPLICATIONS

- High Efficiency Linear Regulators
- Post Regulators for Switching Supplies
- Constant Current Regulators
- Battery Chargers

DEVICE	OUTPUT CURRENT*
LT1083	7.5A
LT1084	5.0A
LT1085	3.0A

PACKAGE/ORDER INFORMATION

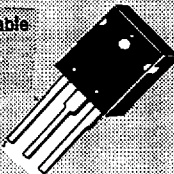
 <p>PIN 1 Adjustable 2. Output 3. Input</p>	ORDER PART NUMBER	<p>FRONT VIEW</p>  <p>PIN 1. Adjustable 2. Output 3. Input</p>	<p>LT1083CM LT1084CM LT1085CM</p>
	<p>LT1083CZ LT1083IZ LT1084CZ LT1084IZ LT1085CZ LT1085IZ</p>		

ABSOLUTE MAXIMUM RATINGS

Power Dissipation	Internally limited	" M " Grades : Control Section	-55°C to 150°C
Input-to-Output Voltage Differential		Power Transistor	-55°C to 200°C
" C " Grades	30V	Storage Temperature Range	-65°C to 150°C
" I " Grades	30V	Lead Temperature (Soldering, 10 sec)	300°C
" M " Grades	35V		
Operating Junction Temperature Range			
" C " Grades: Control Section	0°C to 125°C		
Power Transistor	0°C to 150°C		
" I " Grades : Control Section	-40°C to 125°C		
Power Transistor	-40°C to 150°C		

PRECONDITIONING

100 % thermal shutdown functional test

TYPICAL APPLICATION

5V, 7.5A Regulator

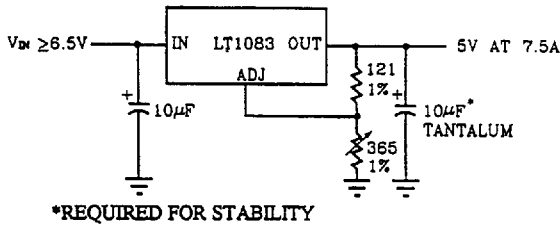

Dropout Voltage vs Output Current

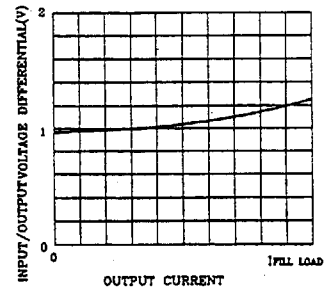

ELECTRICAL CHARACTERISTICS

PARAMETER	CONDITIONS	MIN	TYP	MAX	UNITS
Reference Voltage	$I_{OUT} = 100mA, T_J = 25$ $(V_{IN} - V_{OUT}) = 3V$ $10mA \leq I_{OUT} \leq I_{FULL\ LOAD}$	1.238	1.250	1.262	V
	$1.5V \leq (V_{IN} - V_{OUT}) \leq 25V$ (Notes 3, 5, 6)	1.225	1.250	1.270	V
Line Regulation	$I_{LOAD} = 10mA, 1.5V \leq (V_{IN} - V_{OUT}) \leq 15V, T_J = 25^\circ C$ (Notes 1, 2)	●	0.015	0.2	%
		●	0.035	0.2	%
	M Grades : $15V \leq (V_{IN} - V_{OUT}) \leq 35V$ (Notes 1, 2)	●	0.05	0.5	%
	C, I Grades : $15V \leq (V_{IN} - V_{OUT}) \leq 30V$ (Notes 1, 2)	●	0.05	0.5	%

ELECTRICAL CHARACTERISTICS

PARAMETER	CONDITIONS	MIN	TYP	MAX	UNITS
Load Regulation	$(V_{IN}-V_{OUT}) = 3V$ $10mA \leq I_{OUT} \leq I_{FULL\ LOAD}$ $T_J = 25^\circ C$ (Notes 1,2,3,5)	●	0.1	0.3	%
			0.2	0.4	%
Dropout Voltage	$\Delta V_{REF} = 1\%$, $I_{OUT} = I_{FULL\ LOAD}$ (Notes 4,5,7)	●	1.3	1.5	V
Current Limit	$(V_{IN}-V_{OUT}) = 5V$ $(V_{IN}-V_{OUT}) = 25V$ $(V_{IN}-V_{OUT}) = 5V$ $(V_{IN}-V_{OUT}) = 25V$ $(V_{IN}-V_{OUT}) = 5V$ $(V_{IN}-V_{OUT}) = 25V$	●	8.0	9.5	A
		●	0.4	1.0	A
		●	5.5	6.5	A
		●	0.3	0.6	A
		●	3.2	4.0	A
Minimum Load Current	$(V_{IN}-V_{OUT}) = 25V$	●	5	10	mA
Thermal Regulation	$T_A = 25^\circ C$, 30ms Pulse		0.002	0.010	%/W
			0.003	0.015	%/W
			0.004	0.020	%/W
Ripple Rejection	$f = 120\ Hz$, $C_{ADJ} = 25\ \mu F$, $C_{OUT} = 25\ \mu F$ Tantalum $I_{OUT} = I_{FULL\ LOAD}$, $(V_{IN}-V_{OUT}) = 3V$ (Notes 5,6,7)	●	60	75	dB
Adjust Pin Current	$T_J = 25^\circ C$	●	55		μA
			120		μA
Adjust Pin Current Change	$10mA \leq I_{OUT} \leq I_{FULL\ LOAD}$ $1.5V \leq (V_{IN}-V_{OUT}) \leq 25V$ (Note 5)	●	0.2	5	μA
Temperature Stability		●	0.5		%
Long Term Stability	$T_A = 125^\circ C$, 1000 Hrs		0.3	1	%
RMS Output Noise (% of V_{OUT})	$T_A = 25^\circ C$ $10Hz \leq f \leq 10KHz$		0.003		%
Thermal Resistance Junction-to-Case	Control Circuitry/Power Transistor		0.65/2.7		$^\circ C/W$
		Z,M Package Z.M Packages	0.7/3.0		$^\circ C/W$

The ● denotes the specifications which apply over the full operating temperature range.

Note 1: See thermal regulator specification for change in output voltage due to heating effects. Load and line regulation are measured at a constant junction temperature by low duty cycle pulse testing.

Note 2: Line and load regulation are guaranteed up to the maximum power dissipation (60W for LT1083, 30W for the LT1084(Z) and 30W for the LT1085). Power dissipation is determined by the input/output differential and output current. Guaranteed maximum power dissipation will not be available over the full input/output voltage range.

Note 3: $I_{FULL\ LOAD}$ is defined in the current limit curves

The $I_{FULL\ LOAD}$ curve is defined as the minimum value of current limit as a function of input to output voltage. Note that 60W power dissipation for the LT1083 (30W for the LT1084 (Z), 30W for the LT1085) is only achievable over a limited range of input - to - output voltage.

Note 4: Dropout voltage is specified over the full output current range of the device. Test points and limits are shown on the Dropout Voltage curve.

Note 5: For LT1083 $I_{FULL\ LOAD}$ is 5A for $-55^\circ C \leq T_J < 40^\circ C$ and 7.5A for $T_J \geq 40^\circ C$.

Note 6: $1.7V (V_{IN}-V_{OUT}) \leq 25V$ for TD62084 at $-55^\circ C \leq T_J \leq 40^\circ C$.

Note 7: Dropout is 1.7V maximum for TD62084 at $-55^\circ C \leq T_J \leq 40^\circ C$.

TYPICAL PERFORMANCE CHARACTERISTICS

LT1083
Dropout Voltage

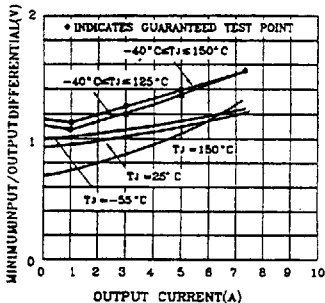

ADJ G01

LT1083
Short-Circuit Current

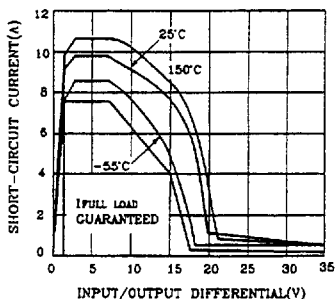

ADJ G02

LT1083
Load Regulation

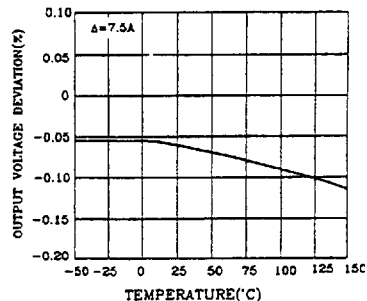

ADJ G03

LT1084
Dropout Voltage

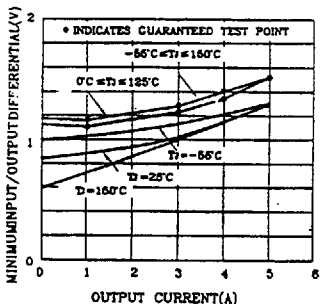

ADJ G04

LT1084
Short-Circuit Current

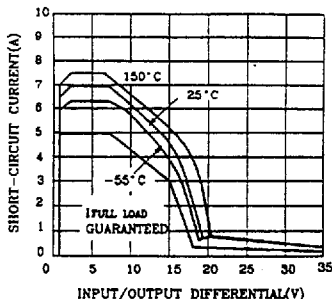

ADJ G05

LT1084
Load Regulation

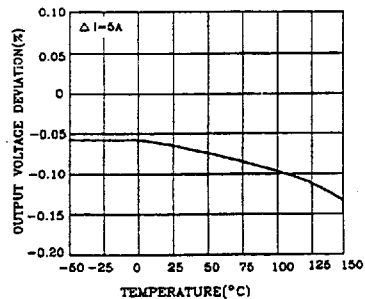

ADJ G06

LT1085
Dropout Voltage

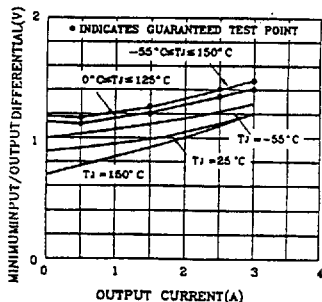

ADJ G07

LT1085
Short-Circuit Current

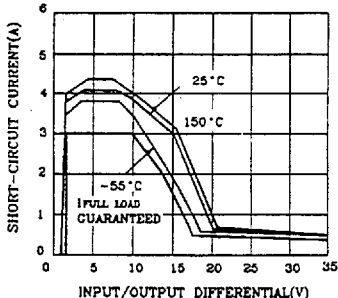

ADJ G08

LT1085
Load Regulation

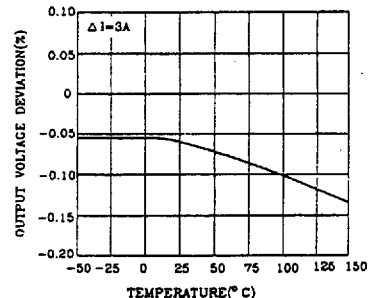

ADJ G09

TYPICAL PERFORMANCE CHARACTERISTICS

Minimum Operating Current

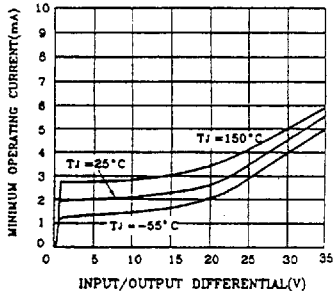

ADJ G10

Temperature Stability

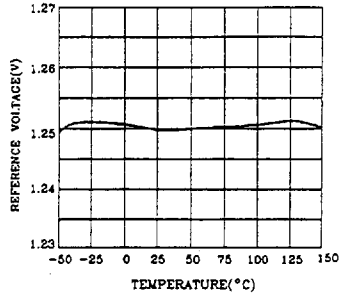

ADJ G11

Adjust Pin Current

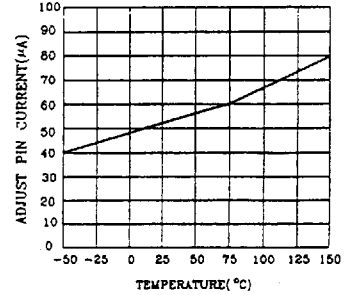

ADJ G12

**LT1083
Ripple Rejection**

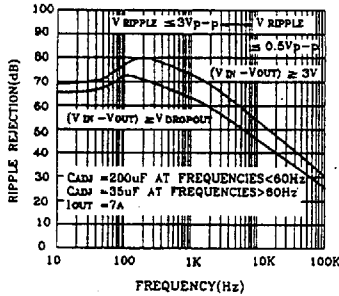

ADJ G13

**LT1083
Ripple Rejection vs Current**

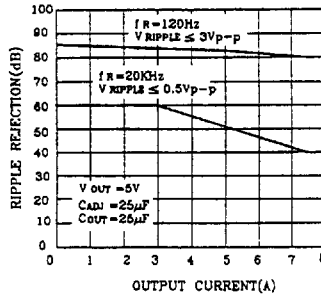

ADJ G14

**LT1083
Maximum Power Dissipation***

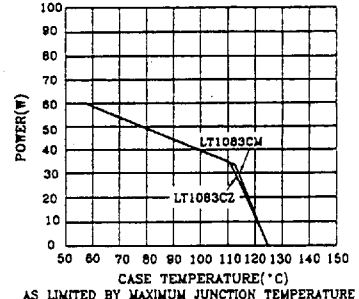

ADJ G15

**LT1084
Ripple Rejection**

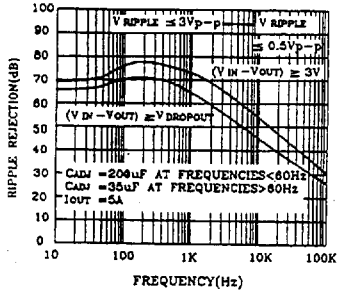

ADJ G16

**LT1084
Ripple Rejection vs Current**

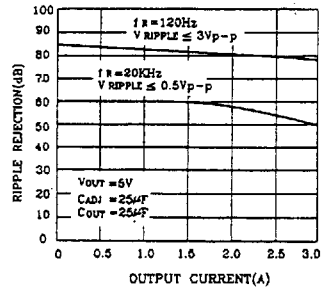

ADJ G17

**LT1084
Maximum Power Dissipation**

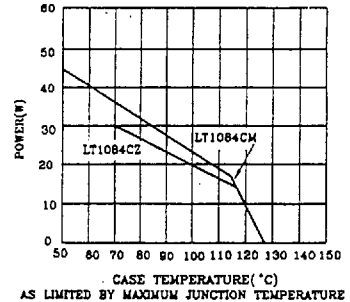

ADJ G18

TYPICAL PERFORMANCE CHARACTERISTICS

**LT1085
Ripple Rejection**

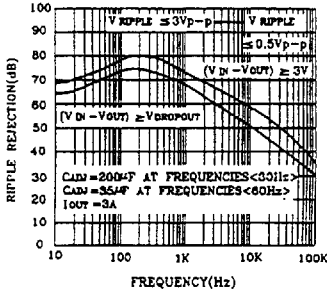

ADJ G19

**LT1085
Ripple Rejection vs Current**

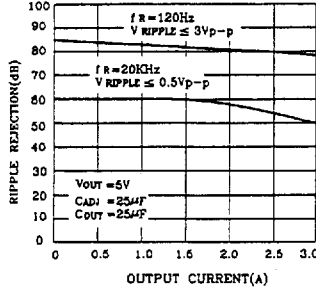

ADJ G20

**LM1085
Maximum Power Dissipation***

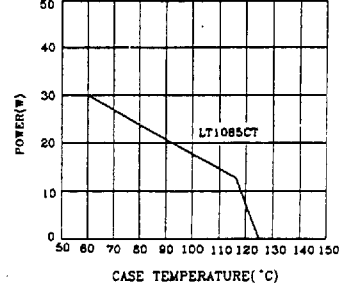

AS LIMITED BY MAXIMUM JUNCTION TEMPERATURE
ADJ G21

**LM1083
Load Transient Response**

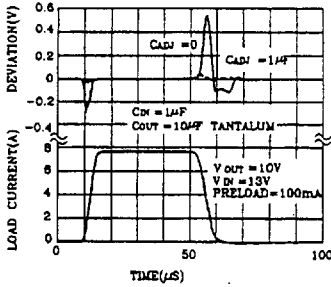

ADJ G22

**LM1083
Load Transient Response**

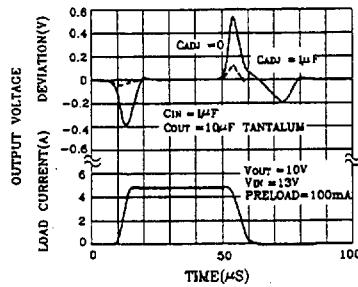

ADJ G23

**LM1083
Load Transient Response**

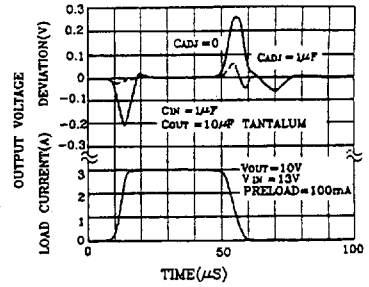

ADJ G24

**LM1083
Line Transient Response**

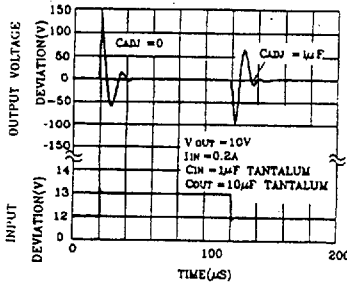

ADJ G25

**LM1084
Line Transient Response**

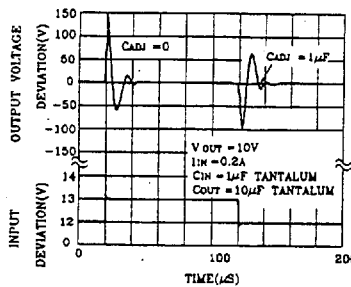

ADJ G26

**LM1085
Line Transient Response**

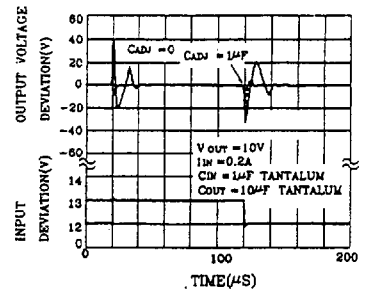

ADJ G27

BLOCK DIAGRAM

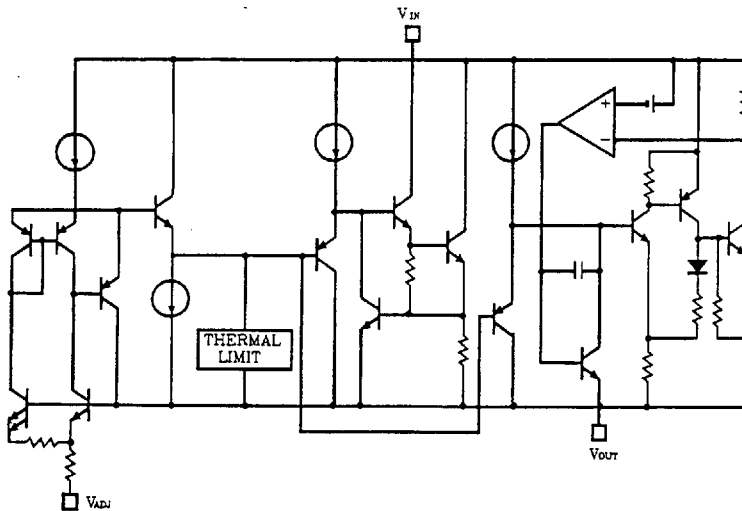

1083/4/5 ADJ BD

The LT1083 family of three-terminal adjustable regulators is easy to use and has all the protection features that are expected in high performance voltage regulators. They are short-circuit protected, and have safe area protection as well as thermal shutdown to turn off the regulator should the junction temperature exceed about 165°C.

These regulators are pin compatible with older three-terminal adjustable devices, offer lower dropout voltage and more precise reference tolerance. Further, the reference stability with temperature is improved over older types of regulators. The only circuit difference between using the LT1083 family and older regulators is that this new family requires an output capacitor for stability.

STABILITY

The circuit design used in the LT1083 family requires the use of an output capacitor as part of the device frequency compensation. For all operating conditions, the addition of 150µF aluminum electrolytic or a 22µF solid tantalum on the output will ensure stability. Normally, capacitors much

smaller than this can be used with the LT1083. Many different types of capacitors with widely varying characteristics are available. These capacitors differ in capacitor tolerance (sometimes ranging up to ± 100%), equivalent series resistance, and capacitance temperature coefficient. The 150µF or 22µF values given will ensure stability.

When the adjustment terminal is bypassed to improve the ripple rejection, the requirement for an output capacitor increases. The value of 22µF tantalum or 150µF aluminum covers all cases of bypassing the adjustment terminal. Without bypassing the adjustment terminal, smaller capacitors can be used with equally good results and the table below shows approximately what size capacitors are needed to ensure stability.

RECOMMENDED CAPACITOR VALUES

INPUT	OUTPUT	ADJUSTMENT
10µF	10µF Tantalum, 50µF Aluminum	None
10µF	55µF Tantalum, 150µF Aluminum	20µF

APPLICATIONS INFORMATION

Normally, capacitor values on the order of $100\mu\text{F}$ are used in the output of many regulators to ensure good transient response with heavy load current changes. Output capacitance can be increased without limit and larger values of output capacitor further improve stability and transient response of the LT1083 regulators.

Another possible stability problem that can occur in monolithic IC regulators is current limit oscillations. These can occur because, in current limit, the safe area protection exhibits a negative impedance. The safe area protection decreases the current limit as the input-to-output voltage increases. That is the equivalent of having a negative resistance since increasing voltage causes current to decrease. Negative resistance during current limit is not unique to the LT1083 series and has been present on all power IC regulators. The value of the negative resistance is a function of how fast the current limit is folded back as input-to-output voltage increases. This negative resistance can react with capacitors or inductors on the input to cause oscillation during current limiting. Depending on the value of series resistance, the overall circuitry may end up unstable. Since this is a system problem, it is not necessarily easy to solve; however, it does not cause any problems with the IC regulator and usually be ignored.

PROTECTION DIODES

In normal operation, the LT1083 family does not need any protection diodes. Older adjustable regulators required protection diodes between the adjustment pin and the output and from the output to the input to prevent over stressing the die. The internal current paths on the LT1083 adjustment pin are limited by internal resistors. Therefore, even with capacitors on the adjustment pin, no protection diode is needed to

ensure device safety under short-circuit conditions.

Diodes between input and output are usually not needed. The internal diode between the input and the output pins of the LT1083 family can handle microsecond surge currents of 50A to 100A. Even with large output capacitances, it is very difficult to get those values of surge currents in normal operations. Only with a high value of output capacitors, such as $1000\mu\text{F}$ to $5000\mu\text{F}$ and with the input pin instantaneously shorted to ground, can damage occur. A crowbar circuit at the input of the LT1083 can generate those kinds of currents, and a diode from output to input is then recommended. Normal power supply cycling or even plugging and unplugging in the system will not generate current large enough to do any damage.

The adjustment pin can be driven on a transient basis $\pm 25\text{V}$, with respect to the output without any device degradation. Of course, as with any IC regulator, exceeding the maximum input to output voltage differential cause the internal transistors to break down and none of the protection circuitry is functional.

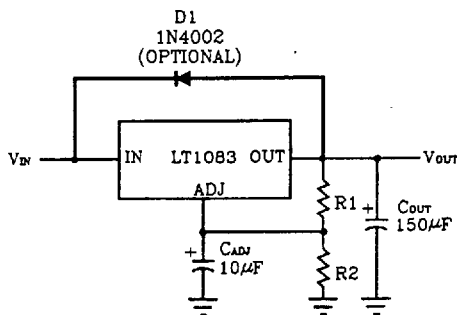

ADJ F00

OVERLOAD RECOVERY

Like any of the IC power regulators, the LT1083 has safe area protection. The safe area protection decreases the current limit as input-to-output voltage increases and keeps the power transistor inside a safe operating region for all values of input-to-output voltage. The LT1083 protection is designed to provide some output current at all values of input-to-output voltage up to the device breakdown.

When power is first turned on, as the input voltage rises, the output follows the input, allowing the regulator to start up into very heavy loads. During the start-up, as the input voltage is rising, the input-to-output voltage differential remains small, allowing the regulator to supply large output currents. With high input voltage, a problem can occur wherein removal of an output short will not allow the output voltage to recover. Older regulators, such as the HB7800 series, also exhibited this phenomenon, so it is not unique to the LT1083.

APPLICATIONS INFORMATION

The problem occurs with a heavy output load when the input voltage is high and the output voltage is low, such as immediately after removal of a short. The load line for such a load may intersect the output current curve at two points. If this happens, there are two stable output operating points for the regulator. With this double intersection, the power supply may need to be cycled down to zero and brought up again to make the output recover.

RIPPLE REJECTION

The typical curves for ripple rejection reflect values for a bypassed adjustment pin. This curve will be true for all values of output voltage. For proper bypassing and ripple rejection approaching the values shown, the impedance of the adjust pin capacitor at the ripple frequency should be less than the value of R_1 , (normally 100Ω to 120Ω). The size of the required adjust pin capacitor is a function of the input ripple frequency.

At 120Hz the adjust pin capacitor should be $25\mu\text{F}$ if $R_1=100\Omega$. At 10KHz only $0.22\mu\text{F}$ is needed.

For circuits without an adjust pin bypass capacitor, the ripple rejection will be a function of output voltage. The output ripple will increase directly as a ratio of the output voltage to the reference voltage (V_{OUT}/V_{REF}). For example, with the output voltage equal to 5V and no adjust pin capacitor, the output ripple will be higher by the ratio of $5V/1.25V$ or four times larger. Ripple rejection will be de-graded by 12dB from the value shown on the typical curve.

OUTPUT VOLTAGE

The LT1083 develops a 1.25V reference voltage between the output and the adjust terminal (see Figure 1). By placing a resistor R_1 between these two terminals, a constant current is caused to flow through R_1 and down through R_2 to set the overall output voltage. Normally this current is the specified minimum load current of 10mA. Because I_{ADJ} is very small and constant when compared with the current through R_1 , it represents a small error and can usually be ignored.

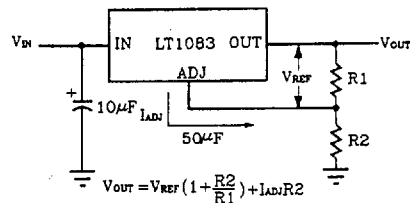

ADJ F01

FIGURE 1. BASIC ADJUSTABLE REGULATOR

LOAD REGULATION

Because the LT1083 is a three-terminal device, it is not possible to provide true remote load sensing. Load regulation will be limited by the resistance of the wire connecting the regulator to the load. The data sheet specification for load regulation is measured at the bottom of the package. Negative side sensing is a true Kelvin connection, with the bottom of the output divider returned to the negative side of the load. Although it may not be immediately obvious, best load regulation is obtained when the top of the resistor divider R1 is connected *directly* to the case *not to the load*. This is illustrated in Figure 2. If R1 were connected to the load, the effective resistance between the regulator and the load would be:

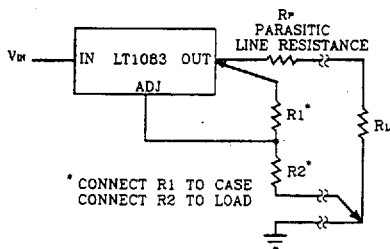

ADJ F02

FIGURE 2. CONNECTIONS FOR BEST LOAD REGULATION

APPLICATIONS INFORMATION

Connected as shown, R_p is not multiplied by the divider ratio. R_p is about 0.004Ω per foot using 16-gauge wire. This translates to $4mV/ft$ at 1A load current, so it is important to keep the positive lead between regulator and load as short as possible and use large wire or PC board traces.

THERMAL CONSIDERATION

The LT1083 series of regulators have internal power and thermal limited circuitry designed to protect the device

under overload conditions. For continuous normal load conditions however, maximum junction temperature ratings must not be exceeded. It is important to give careful consideration to all sources of thermal resistance from junction to ambient. This includes junction-to-case, case-to-heat sink interface, and heat sink resistance itself. New thermal resistance specifications have been developed to more accurately reflect device temperature and ensure safe operating temperatures. The data section for these new regulators provides a separate thermal resistance and maximum junction temperature for both the *Control Section* and the *Power Transistor*. Previous regulators, with a single junction-to-case thermal resistance specification, used an average of two values provided here and therefore could allow excessive junction temperatures under certain conditions of ambient temperature and heat sink resistance. To avoid this possibility, calculations should be made for both sections to ensure that both thermal limits are met.

Junction-to-case thermal resistance is specified from the IC junction to the bottom of the case directly below the die. This is the lowest resistance path for heat flow. Proper mounting is required to ensure the best possible thermal flow from this area of the package to the heat sink. Thermal compound at the case-to-heat sink interface is strongly recommended. If the case of the device must be electrically isolated, a thermally conductive spacer can be used, as long as its added contribution to thermal resistance is considered. Note that the case of all devices in this series is electrically connected to the output.

For example, using an LT1083 (TO-3P, Commercial) and assuming: V_{IN} (max continuous) = 9V, V_{OUT} = 5V, I_{OUT} = 6A,

$$T_A = 75^\circ\text{C}, \theta_{\text{HEAT SINK}} = 1^\circ\text{C/W}, \theta_{\text{CASE-TO-HEAT SINK}} = 0.2^\circ\text{C/W} \text{ for K package with thermal compound.}$$

Power dissipation under these conditions is equal to: $P_D = (V_{IN} - V_{OUT})(I_{OUT}) = 24\text{W}$

Junction temperature will be equal to: $T_J = T_A + P_D(\theta_{\text{HEAT SINK}} + \theta_{\text{CASE-TO-HEAT SINK}} + \theta_{JC})$

For the Control Section: $T_J = 75^\circ\text{C} + 24\text{W}(1^\circ\text{C/W} + 0.2^\circ\text{C/W} + 0.6^\circ\text{C/W}) = 118^\circ\text{C}$ $118^\circ\text{C} < 150^\circ\text{C} = T_{MAX}$ (Power Transistor

Commercial Range)

For the Power Transistor: $T_J = 75^\circ\text{C} + 24\text{W}(1^\circ\text{C/W} + 0.2^\circ\text{C/W} + 1.6^\circ\text{C/W}) = 142^\circ\text{C}$ $142^\circ\text{C} < 150^\circ\text{C} = T_{MAX}$ (Power Transistor

Commercial Range)

In both cases the junction temperature is below the maximum rating for the respective sections, ensuring reliable operation.

TYPICAL APPLICATIONS

7.5 Variable Regulator

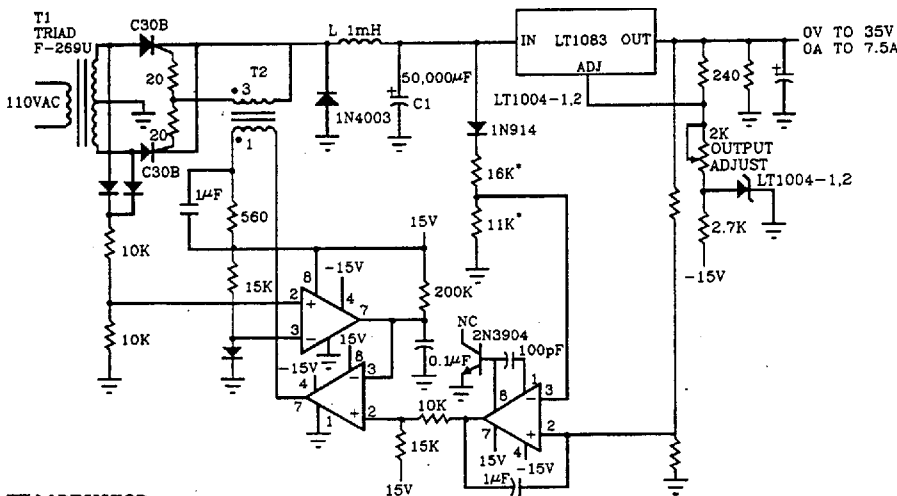

- * 1% FILM RESISTOR
- L: DALE TO-5 TYPE
- T2: STANCOR 11Z-2003

GENERAL PURPOSE REGULATOR WITH SCR PREREGULATOR
TO LOWER POWER DISSIPATION. ABOUT 1.7V DIFFERENTIAL
IS MAINTAINED ACROSS THE LT1083 INDEPENDENT OF OUTPUT
VOLTAGE AND LOAD CURRENT

ADJ TA10

PARALLELING REGULATORS

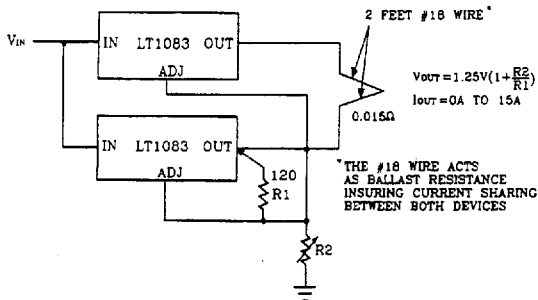

1083/4/5 ADJ TA03

IMPROVING RIPPLE REJECTION

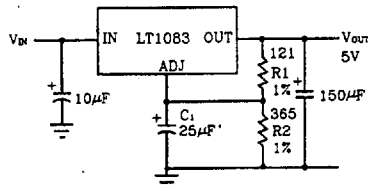

*C1 IMPROVES RIPPLE REJECTION
Xc SHOULD BE < R1 AT RIPPLE FREQUENCY

1083/4/5 ADJ TA04

REMOTE SENSING

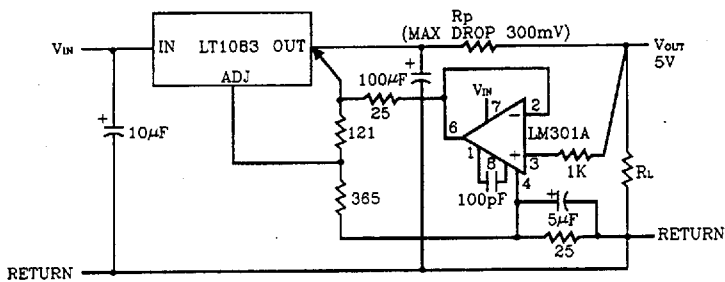

1083/4/5 ADJ TA05

HIGH EFFICIENCY REGULATOR WITH SWITCHING PREREGULATOR

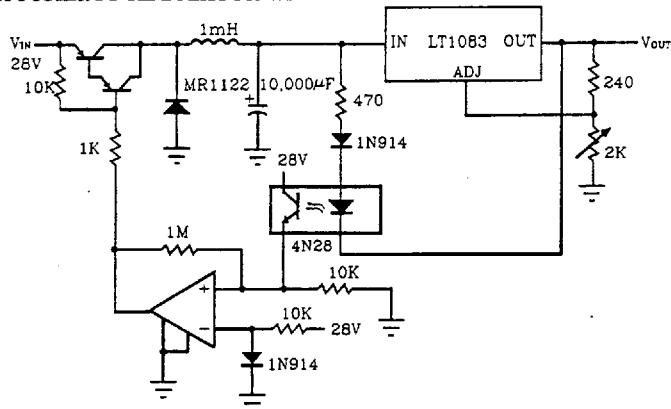

ADJ TA06

1.2V TO 15V ADJUSTABLE REGULATOR

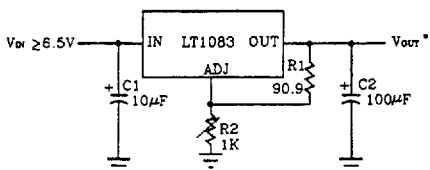

NEEDED IF DEVICES IS FAR FROM FILTER CAPACITORS
 $V_{OUT} = 1.25V(1 + \frac{R2}{R1})$

ADJ TA07

5V REGULATOR WITH SHUTDOWN *

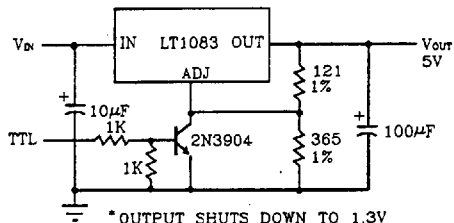

* OUTPUT SHUTS DOWN TO 1.3V

ADJ TA08

AUTOMATIC LIGHT CONTROL

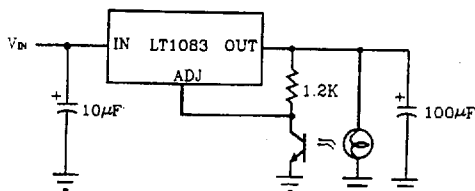

ADJ TA09

PROTECTED HIGH CURRENT LAMP DRIVER

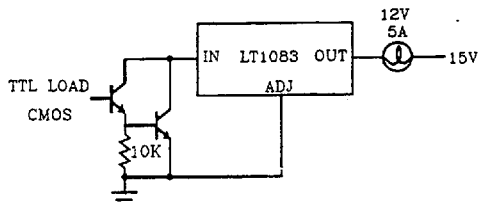

ADJ TA10