

2.3W DUAL AUDIO POWER AMPLIFIER

The KA2206 is a monolithic integrated circuit consisting of a 2-channel power amplifier. It is suitable for stereo and bridge amplifier application of radio cassette tape recorders.

FEATURES

- High output power
Stereo : $P_o=2.3W$ (Typ) at $V_{cc}=9V$, $R_L=4\Omega$.
Bridge : $P_o=4.7W$ (Typ) at $V_{cc}=9V$, $R_L=8\Omega$.
- Low switching distortion at high frequency.
- Small shock noise at the time of power on/off due to a built-in muting circuit.
- Good ripple rejection due to built-in ripple filter.
- Good channel separation.
- Soft tone at the time of output saturation.
- Closed loop voltage gain fixed 45dB(Bridge : 51dB) but availability with external resistor added.
- Minimum number of external parts required.
- Easy to design radiator fin.

ORDERING INFORMATION

Device	Package	Operating Temperature
KA2206	16DIP	-20 ~ +70 °C

16 DIP

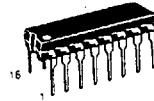

BLOCK DIAGRAM

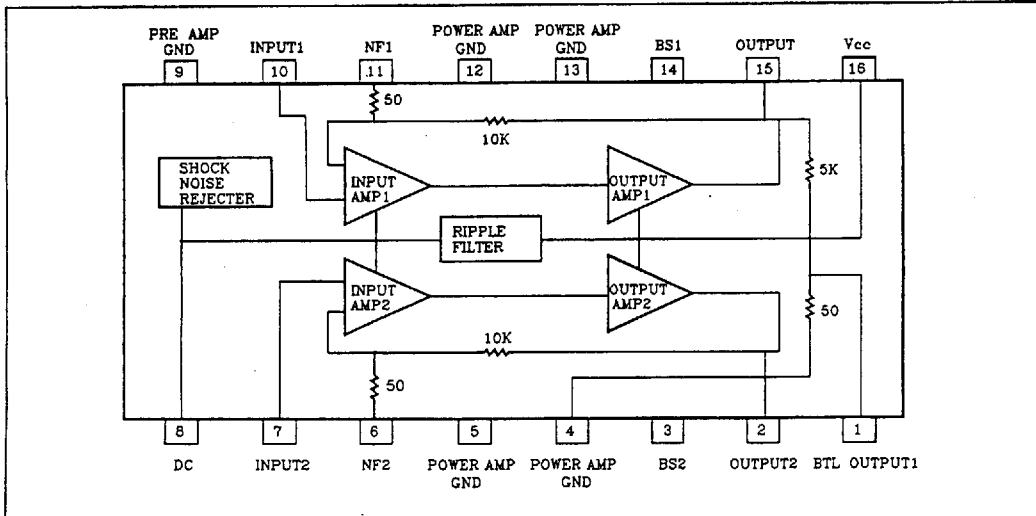

ABSOLUTE MAXIMUM RATINGS(Ta=25℃)

Characteristics	Symbol	Value	Unit
Supply Voltage	Vcc	15	V
Power Dissipation	Pd	4*	W
Operating Temperature	Topr	-20 ~ +70	℃
Storage Temperature	Tstg	-40 ~ +150	℃

*Fin is soldering on the PCB

ELECTRICAL CHARACTERISTICS (Ta=25℃, Vcc=9V, f=1KHz, Rg=600Ω, unless otherwise specified)

Characteristic	Symbol	Test Conditions	Min	Typ	Max	Unit	
Operating Supply Voltage	Vcc			9	11	V	
Quiescent Circuit Current	Icc	Vi=0, Stereo		40	55	mA	
Closed Loop Voltage Gain	Av	Stereo	Vi=-45dBm	43	45	47	dB
		Bridge		49	51	53	
Channel Balance	CB	Stereo	-1	0	+1	dB	
Output Power	Po	Stereo	R _L =4Ω, THD=10%	1.7	2.3	W	
			R _L =8Ω, THD=10%		1.3	W	
		Bridge	R _L =8Ω, THD=10%		4.7	W	
Total Harmonic Distortion	THD	Stereo	Po=250mW, R _L =4Ω		0.3	1.5	%
		Bridge			0.5	%	
Input Resistance	Ri		21	30		KΩ	
Ripple Rejection	RR	Stereo, Rg=0Ω, Vr=150mV f=100Hz	40	46		dB	
Output Noise Voltage	V _{NO}	Stereo, Rg=0Ω		0.3	1.0	mV	
		Stereo, Rg=10KΩ		0.5	2.0	mV	
Cross Talk	CT	Stereo, Rg=10KΩ, Vo=0dBm	40	55		dB	

TYPICAL APPLICATION CIRCUIT: Stereo Amplifier

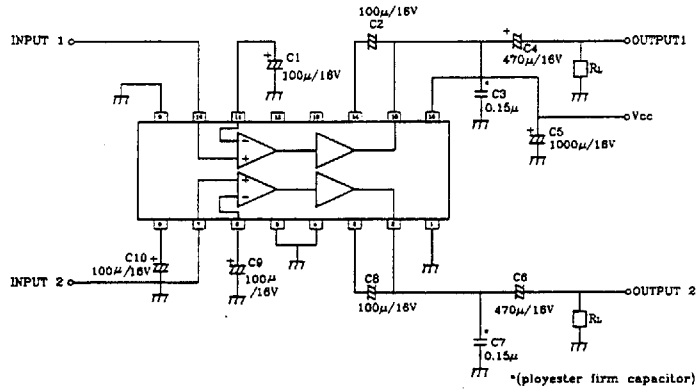

Fig.2

TYPICAL APPLICATION CIRCUIT: Bridge Amplifier

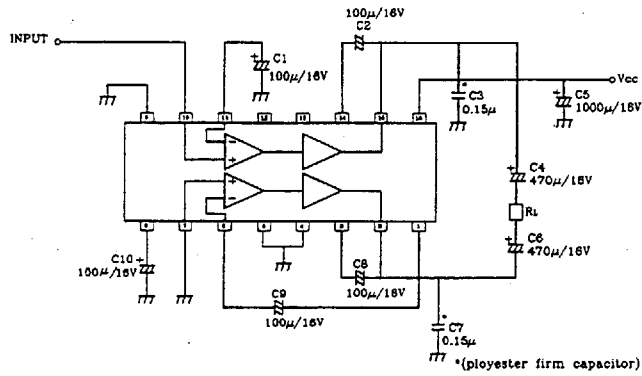
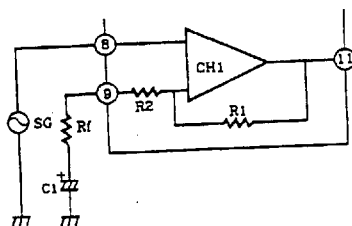

Fig.3

VOLTAGE GAIN ADJUSTMENT

1. Stereo application



I) Fixed voltage gain
(Pin 9 connected to GND directly)

$$A_v = 20 \log \frac{R_1}{R_2} \text{ (dB)}$$

II) Variable voltage gain
(Rf and C1 connected with pin 9)

$$A_v = 20 \log \frac{R_1}{R_2 + R_f} \text{ (dB)}$$

2. Bridge application

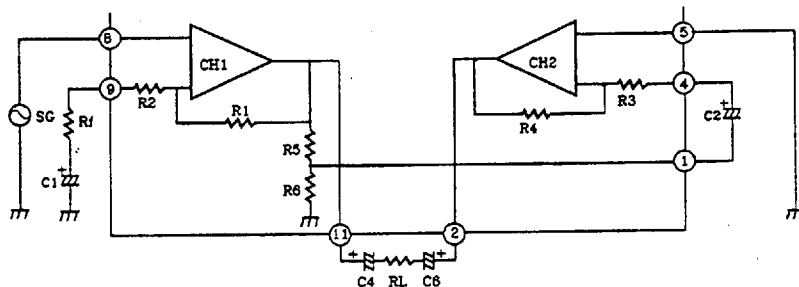

I) Fixed voltage gain (Pin 9 connected to GND directly)

$$A_v = 20 \log \frac{R_1}{R_2} + 6 \text{ (dB)}$$

II) Variable voltage gain (Rf and C1 connected with pin 9)

$$A_v = 20 \log \frac{R_1}{R_2 + R_f} + 6 \text{ (dB)}$$

OUTPUT POWER-INPUT VOLTAGE

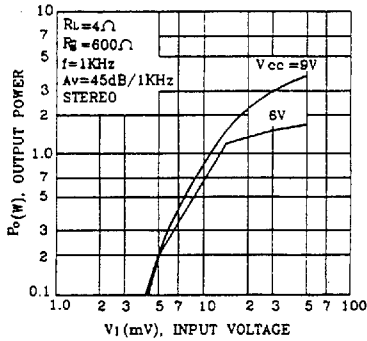

FREQUENCY RESPONSE

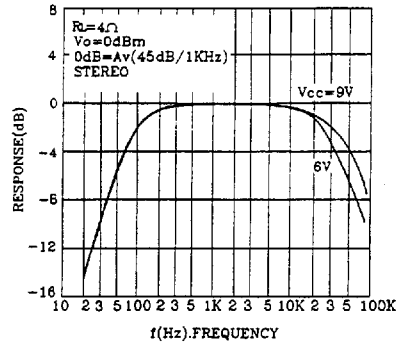

VOLTAGE GAIN-FREQUENCY

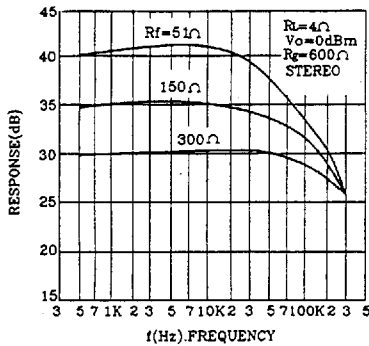

TOTAL HARMONIC DISTORTION-OUTPUT POWER

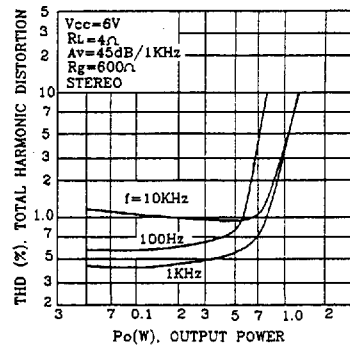

TOTAL HARMONIC DISTORTION-OUTPUT POWER

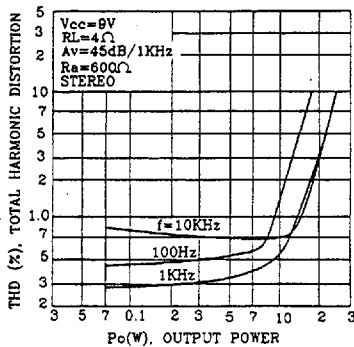

TOTAL HARMONIC DISTORTION-FREQUENCY

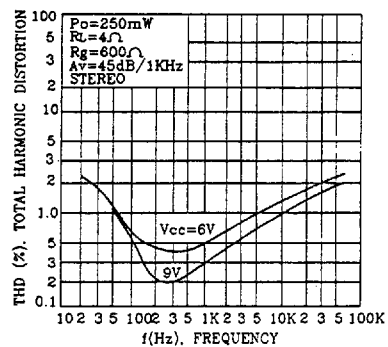

TOTAL HARMONIC DISTORTION-FREQUENCY

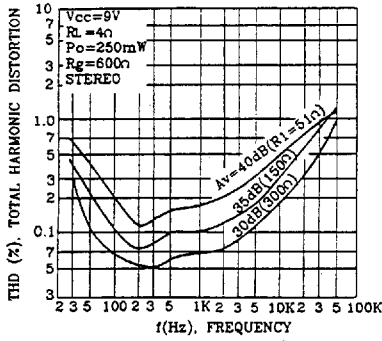

CHANNEL SEPARATION-FREQUENCY

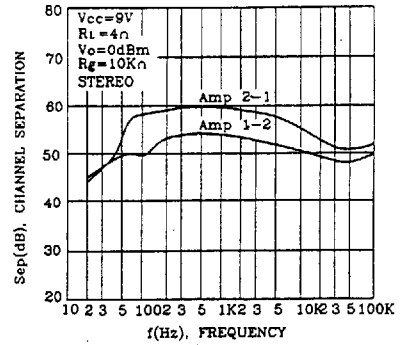

OUTPUT RIPPLE VOLTAGE OUTPUT NOISE VOLTAGE GENERATOR RESISTANCE

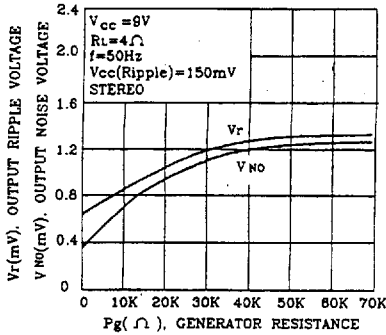

POWER DISSIPATION-OUTPUT POWER

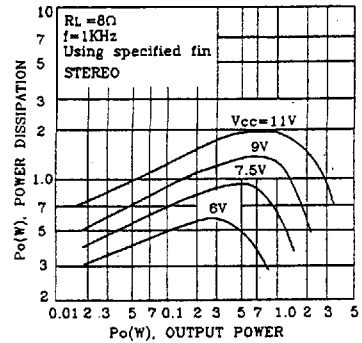

POWER DISSIPATION-OUTPUT POWER

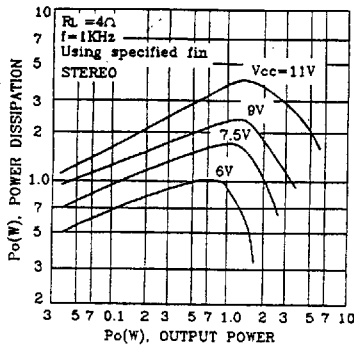

OUTPUT POWER-SUPPLY VOLTAGE

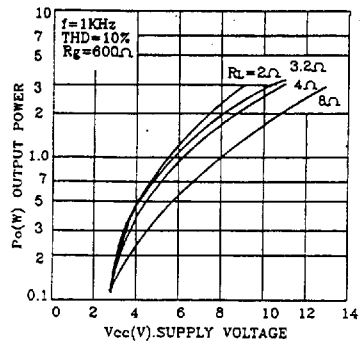

QUIESCENT CIRCUIT CURRENT SUPPLY VOLTAGE

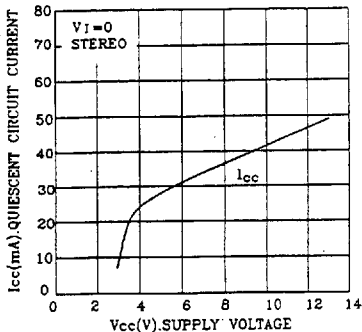

QUIESCENT CIRCUIT CURRENT-AMBIENT TEMPERATURE

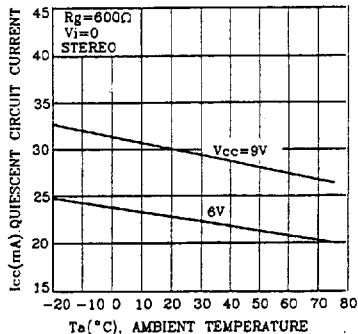

OUTPUT POWER-INPUT VOLTAGE

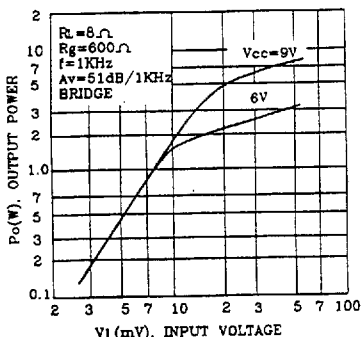

FREQUENCY RESPONSE

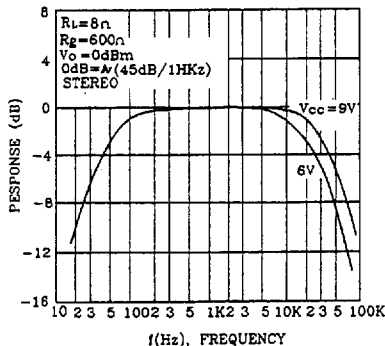

TOTAL HARMONIC DISTORTION-OUTPUT POWER

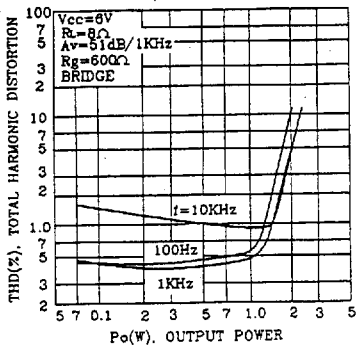

TOTAL HARMONIC DISTORTION-OUTPUT POWER

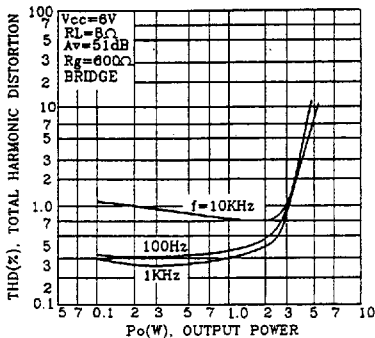

TOTAL HARMONIC DISTORTION-FREQUENCY

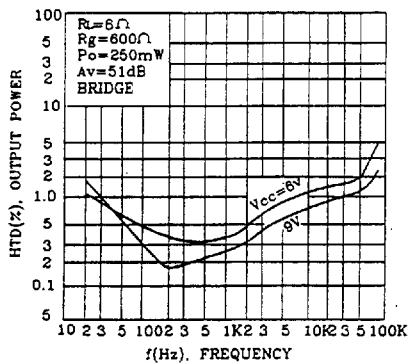

POWER DISSIPATION-OUTPUT POWER

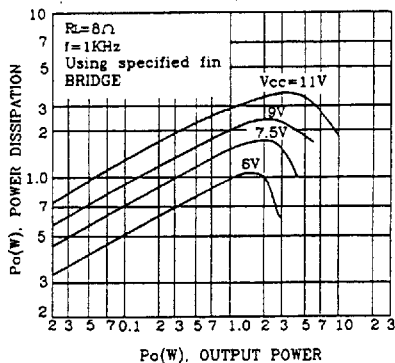

OUTPUT POWER-SUPPLY VOLTAGE

