



IRF740FP 10A 400V N CHANNEL POWER MOSFET

Description

Mechanical Dimensions

IRF740FP

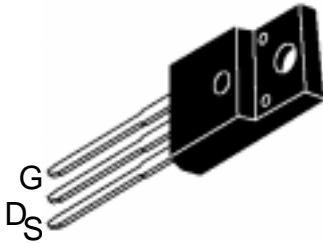

ITO-220AB

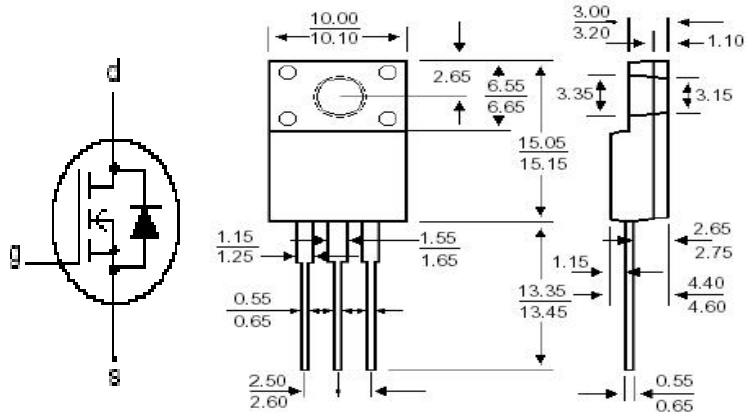

DIMENSION IN MM

GENERAL DESCRIPTION

This high voltage MOSFET uses an advanced termination scheme to provide enhanced voltage-blocking capability without degrading performance over time. In addition, this advanced MOSFET is designed to withstand high energy in avalanche and commutation modes. The new energy efficient design also offers a drain-to-source diode with a fast recovery time. Designed for high voltage, high speed switching applications in power supplies, converters and PWM motor controls, these devices are particularly well suited for bridge circuits where diode speed and commutating safe operating areas are critical and offer additional and safety margin against unexpected voltage transients.

FEATURES

- ◆ Robust High Voltage Termination
- ◆ Avalanche Energy Specified
- ◆ Source-to-Drain Diode Recovery Time Comparable to a Discrete Fast Recovery Diode
- ◆ Diode is Characterized for Use in Bridge Circuits
- ◆ I_{BSS} and $V_{DS(on)}$ Specified at Elevated Temperature

ABSOLUTE MAXIMUM RATINGS

Rating	Symbol	Value	Unit
Drain to Current – Continuous	I_D	10	A
– Pulsed	I_{DM}	40	
Gate-to-Source Voltage – Continue	V_{GS}	± 20	V
– Non-repetitive	V_{GSM}	± 40	V
Total Power Dissipation	P_D	125	W
Derate above 25°C		1.0	W/°C
Operating and Storage Temperature Range	T_J, T_{STG}	-55 to 150	°C
Single Pulse Drain-to-Source Avalanche Energy – $T_J = 25^\circ\text{C}$ ($V_{DD} = 100\text{V}, V_{GS} = 10\text{V}, I_L = 10\text{A}, L = 6\text{mH}, R_G = 25\Omega$)	E_{AS}	300	mJ
Thermal Resistance – Junction to Case	θ_{JC}	1.7	°C/W
– Junction to Ambient	θ_{JA}	62.5	
Maximum Lead Temperature for Soldering Purposes, 1/8" from case for 10 seconds	T_L	260	°C



IRF740FP 10A 400V N CHANNEL POWER MOSFET

ELECTRICAL CHARACTERISTICS

Unless otherwise specified, $T_J = 25^\circ\text{C}$.

Characteristic	Symbol	IRF740			Units
		Min	Typ	Max	
Drain-Source Breakdown Voltage ($V_{GS} = 0\text{ V}$, $I_D = 250\ \mu\text{A}$)	$V_{(BR)DSS}$	400			V
Drain-Source Leakage Current ($V_{DS} = 400\text{ V}$, $V_{GS} = 0\text{ V}$) ($V_{DS} = 400\text{ V}$, $V_{GS} = 0\text{ V}$, $T_J = 125^\circ\text{C}$)	I_{DSS}			0.25 1.0	mA
Gate-Source Leakage Current-Forward ($V_{gsf} = 20\text{ V}$, $V_{DS} = 0\text{ V}$)	I_{GSSF}			100	nA
Gate-Source Leakage Current-Reverse ($V_{gsr} = 20\text{ V}$, $V_{DS} = 0\text{ V}$)	I_{GSSR}			-100	nA
Gate Threshold Voltage ($V_{DS} = V_{GS}$, $I_D = 250\ \mu\text{A}$)	$V_{GS(th)}$	2.0		4.0	V
Static Drain-Source On-Resistance ($V_{GS} = 10\text{ V}$, $I_D = 5.0\text{A}$) *	$R_{DS(on)}$		0.4	0.55	Ω
Drain-Source On-Voltage ($V_{GS} = 10\text{ V}$) ($I_D = 5.0\text{ A}$)	$V_{DS(on)}$			6.0	V
Forward Transconductance ($V_{DS} = 50\text{ V}$, $I_D = 5.0\text{A}$) *	g_{FS}		4.0		mhos
Input Capacitance	$(V_{DS} = 25\text{ V}$, $V_{GS} = 0\text{ V}$, $f = 1.0\text{ MHz}$)	C_{iss}	1570		pF
Output Capacitance		C_{oss}	230		pF
Reverse Transfer Capacitance		C_{rss}	55		pF
Turn-On Delay Time	$(V_{DD} = 200\text{ V}$, $I_D = 10.0\text{ A}$, $V_{GS} = 10\text{ V}$, $R_G = 10\Omega$) *	$t_{d(on)}$	25		ns
Rise Time		t_r	37		ns
Turn-Off Delay Time		$t_{d(off)}$	75		ns
Fall Time		t_f	31		ns
Total Gate Charge	$(V_{DS} = 320\text{ V}$, $I_D = 10.0\text{ A}$, $V_{GS} = 10\text{ V}$)*	Q_g	46	63	nC
Gate-Source Charge		Q_{gs}	10		nC
Gate-Drain Charge		Q_{gd}	23		nC
Internal Drain Inductance (Measured from the drain lead 0.25" from package to center of die)	L_D		4.5		nH
Internal Drain Inductance (Measured from the source lead 0.25" from package to source bond pad)	L_S		7.5		nH
SOURCE-DRAIN DIODE CHARACTERISTICS					
Forward On-Voltage(1)	$(I_S = 10.0\text{ A}$, $V_{GS} = 0\text{ V}$, $d_I/d_t = 100\text{A}/\mu\text{s}$)	V_{SD}		2.0	V
Forward Turn-On Time		t_{on}	**		ns
Reverse Recovery Time		t_{rr}	250		ns

* Pulse Test: Pulse Width $\leq 300\mu\text{s}$, Duty Cycle $\leq 2\%$

** Negligible, Dominated by circuit inductance



IRF740FP 10A 400V N CHANNEL POWER MOSFET

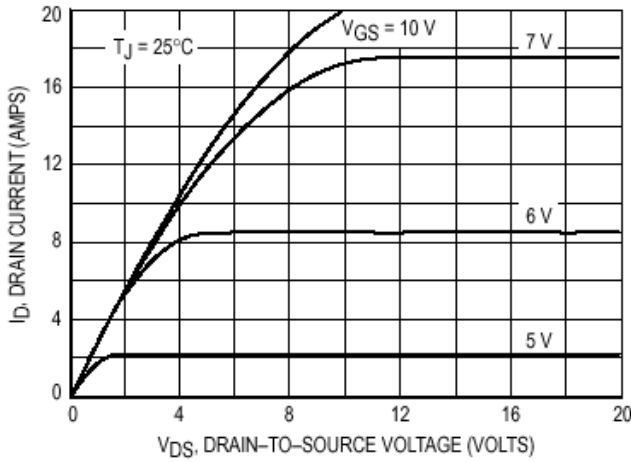

Figure 1. On-Region Characteristics

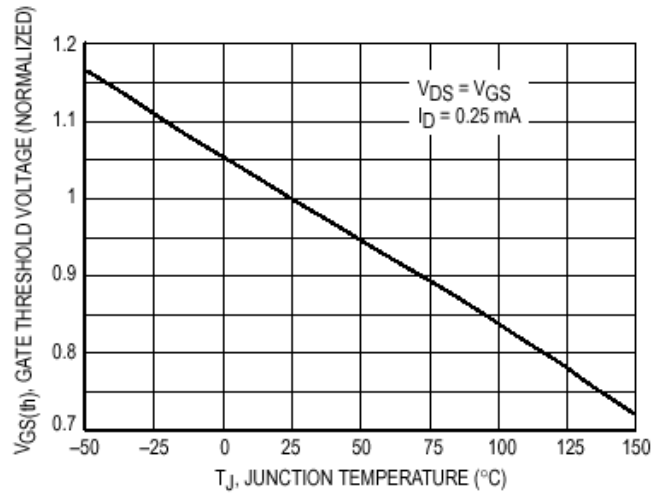

Figure 2. Gate-Threshold Voltage Variation With Temperature

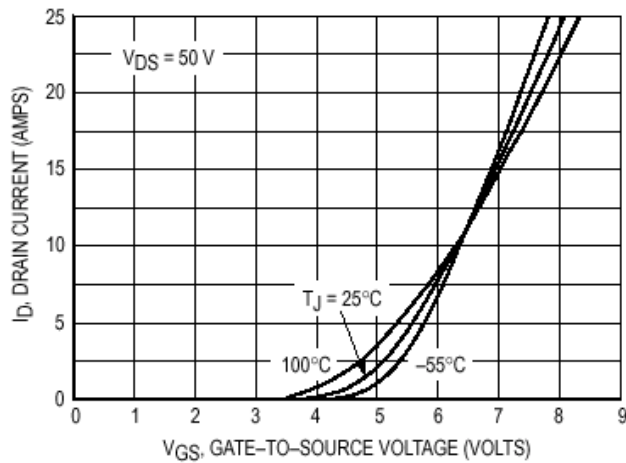

Figure 3. Transfer Characteristics

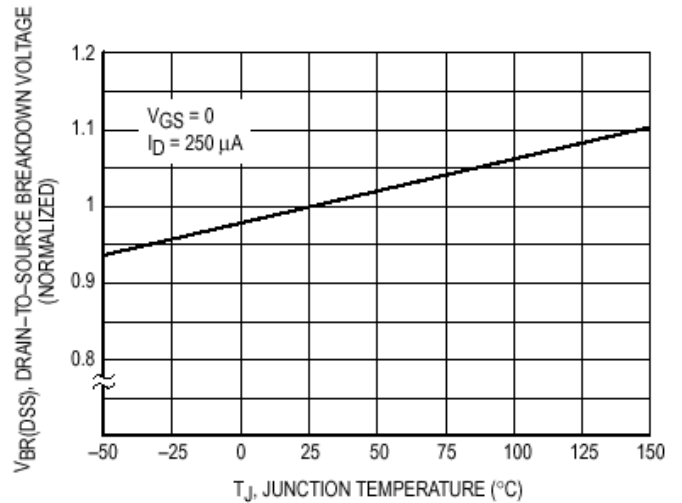

Figure 4. Breakdown Voltage Variation With Temperature

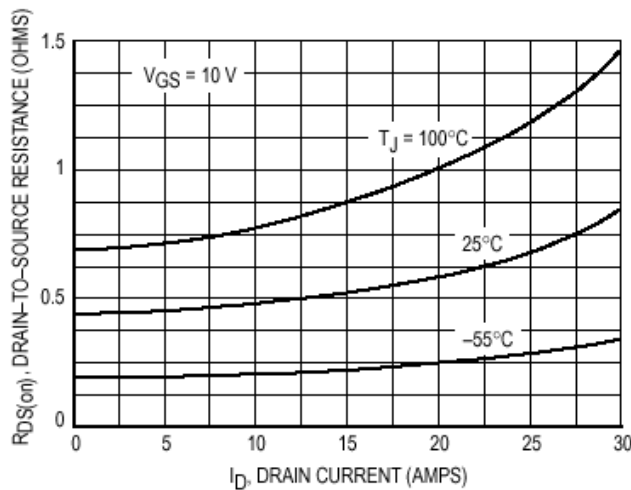

Figure 5. On-Resistance versus Drain Current

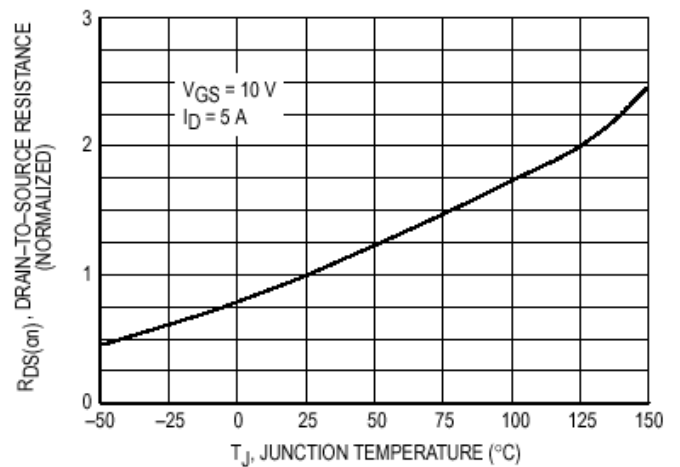

Figure 6. On-Resistance Variation With Temperature