

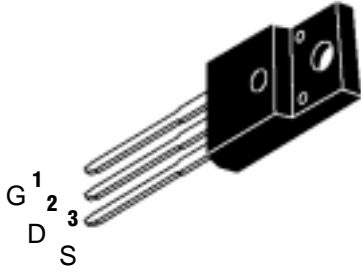

Description

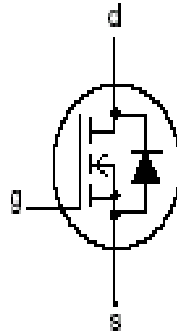

ITO-220



Mechanical Dimensions

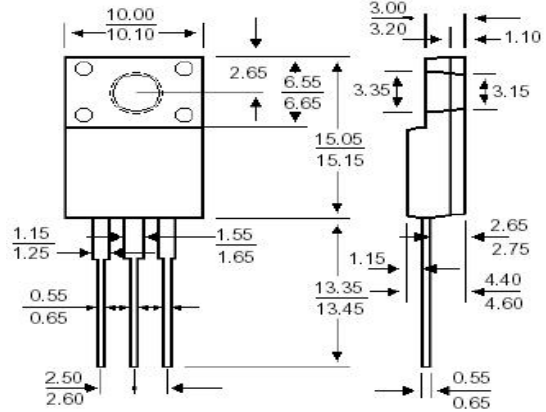

Dimension in mm

GENERAL DESCRIPTION

This Power MOSFET is designed for low voltage, high speed power switching applications such as switching regulators, converters, solenoid and relay drivers.

FEATURES

- ◆ Higher Current Rating
- ◆ Lower $r_{DS(ON)}$, Lower Capacitances
- ◆ Lower Total Gate Charge
- ◆ Tighter VSD Specifications
- ◆ Avalanche Energy Specified

ABSOLUTE MAXIMUM RATINGS

Rating	Symbol	Value	Unit
Drain to Current – Continuous	I_D	6.0	A
– Pulsed (Note 1)	I_{DM}	21	
Gate-to-Source Voltage – Continue	V_{GS}	± 20	V
Total Power Dissipation	P_D	96	W
Derate above 25°C		0.77	W/°C
Single Pulse Drain-to-Source Avalanche Energy – $T_J = 25^\circ\text{C}$ ($V_{DD} = 100\text{V}$, $V_{GS} = 10\text{V}$, $I_L = 6\text{A}$, $L = 10\text{mH}$, $R_G = 25\Omega$)	E_{AS}	180	mJ
Operating and Storage Temperature Range	T_J, T_{STG}	-55 to 150	°C
Thermal Resistance – Junction to Case	θ_{JC}	1.70	°C/W
– Junction to Ambient	θ_{JA}	62	
Maximum Lead Temperature for Soldering Purposes, 1/8" from case for 10 seconds	T_L	300	°C



IRF730FP 6.0A 400V N CHANNEL POWER MOSFET

ELECTRICAL CHARACTERISTICS

Unless otherwise specified, $T_J = 25^\circ\text{C}$.

Characteristic	Symbol	IRF730			Units	
		Min	Typ	Max		
Drain-Source Breakdown Voltage ($V_{GS} = 0\text{ V}$, $I_D = 250\ \mu\text{A}$)	$V_{(BR)DSS}$	400			V	
Drain-Source Leakage Current ($V_{DS} = 400\text{V}$, $V_{GS} = 0\text{ V}$) ($V_{DS} = 400\text{V}$, $V_{GS} = 0\text{ V}$, $T_J = 125^\circ\text{C}$)	I_{DSS}			25 100	μA	
Gate-Source Leakage Current-Forward ($V_{gsf} = 20\text{ V}$, $V_{DS} = 0\text{ V}$)	I_{GSSF}			100	nA	
Gate-Source Leakage Current-Reverse ($V_{gsr} = -20\text{ V}$, $V_{DS} = 0\text{ V}$)	I_{GSSR}			-100	nA	
Gate Threshold Voltage ($V_{DS} = V_{GS}$, $I_D = 250\ \mu\text{A}$)	$V_{GS(th)}$	2.0		4.0	V	
Static Drain-Source On-Resistance ($V_{GS} = 10\text{ V}$, $I_D = 3\text{A}$) (Note 4)	$R_{DS(on)}$			1.0	Ω	
Forward Transconductance ($V_{DS} = 50\text{V}$, $I_D = 3\text{ A}$) (Note 4)	g_{FS}	2.9			mhos	
Input Capacitance	$(V_{DS} = 25\text{ V}$, $V_{GS} = 0\text{ V}$, $f = 1.0\text{ MHz}$)	C_{iss}		515	720	pF
Output Capacitance		C_{oss}		185	260	pF
Reverse Transfer Capacitance		C_{rss}		15	30	pF
Turn-On Delay Time	$(V_{DD} = 200\text{ V}$, $I_D = 6\text{ A}$, $R_G = 9.1\Omega$, $V_{GS} = 10\text{ V}$) (Note 4)	$t_{d(on)}$		7	10	ns
Rise Time		t_r		11	20	ns
Turn-Off Delay Time		$t_{d(off)}$		19	40	ns
Fall Time		t_f		10	20	ns
Total Gate Charge	$(V_{DS} = 320\text{V}$, $I_D = 6\text{ A}$, $V_{GS} = 10\text{ V}$) (Note 4)	Q_g		9.5		nC
Gate-Source Charge		Q_{gs}		2		nC
Gate-Drain Charge		Q_{gd}		3		nC
Internal Drain Inductance (Measured from the drain lead 0.25" from package to center of die)	L_D			4.5		nH
Internal Drain Inductance (Measured from the source lead 0.25" from package to source bond pad)	L_S			7.5		nH
SOURCE-DRAIN DIODE CHARACTERISTICS						
Reverse Recovery Charge	$I_F = 6\text{ A}$, $di/dt = 100\text{A}/\mu\text{s}$, $T_J = 25^\circ\text{C}$ (Note 4)	Q_{rr}		1.6		μC
Forward Turn-On Time		t_{on}		**		
Reverse Recovery Time		t_{rr}		270		ns
Diode Forward Voltage	$I_S = 6\text{ A}$, $V_{GS} = 0\text{ V}$, $T_J = 25^\circ\text{C}$ (Note 4)	V_{SD}			1.5	V

Note

- Repetitive rating; pulse width limited by max. junction temperature
- $V_{DD} = 50\text{V}$, starting $T_J = 25^\circ\text{C}$, $L=24\text{mH}$, $R_G = 25\Omega$, $I_{AS} = 4.5\text{ A}$
- $I_{SD} \leq 4.5\text{ A}$, $di/dt \leq 75\text{A}/\mu\text{s}$, $V_{DD} \leq V_{(BR)DSS}$, $T_J \leq 150^\circ\text{C}$
- Pulse Test: Pulse Width $\leq 300\mu\text{s}$, Duty Cycle $\leq 2\%$

** Negligible, Dominated by circuit inductance



IRF730FP 6.0A 400V N CHANNEL POWER MOSFET

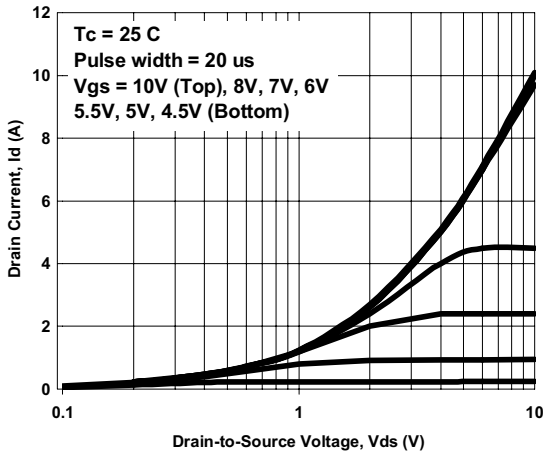

Figure 1. Id versus Vds Curve

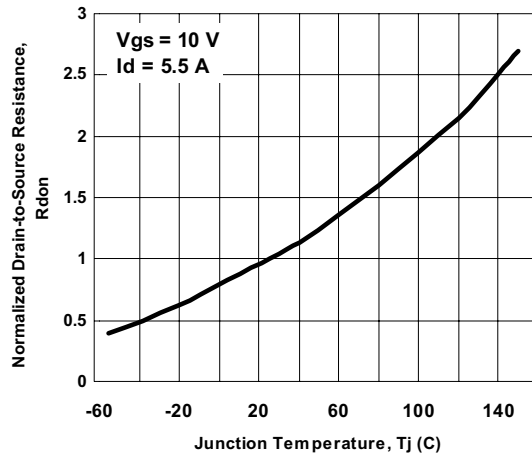

Figure 2. Rdon versus Tj Curve

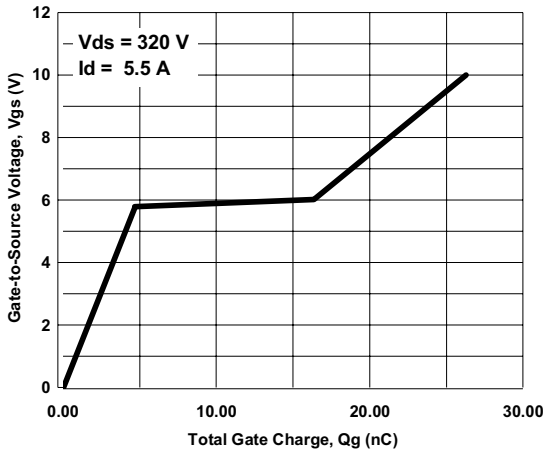

Figure 3. Vgs versus Qg Curve

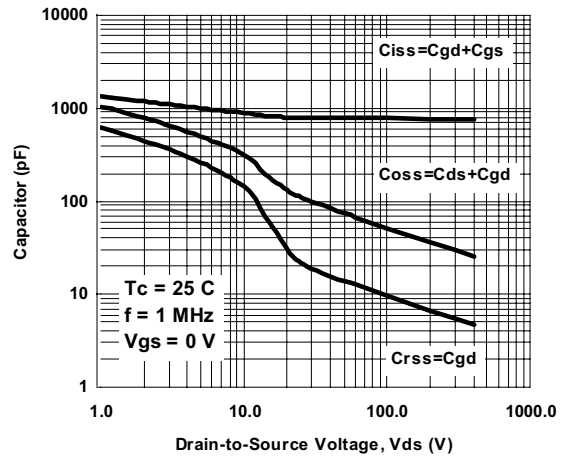

Figure 4. Capacitor versus Vds Curve

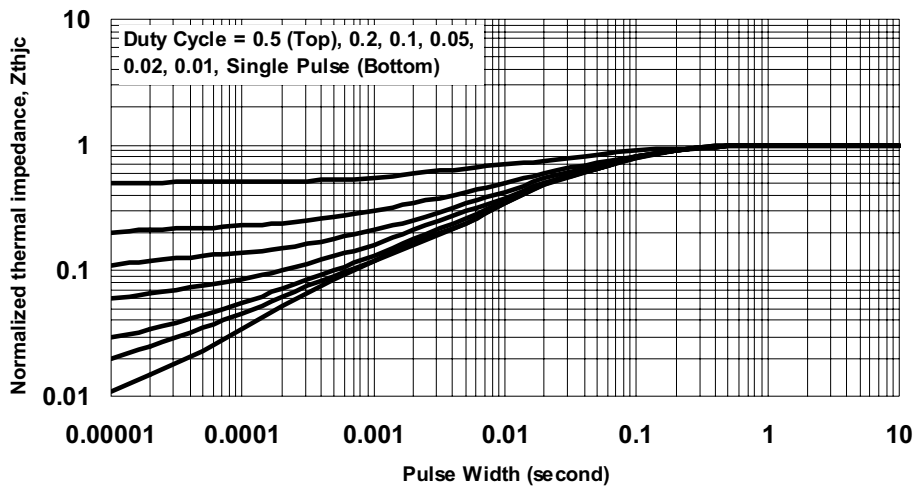

Figure 5. Transient thermal impedance Curve