



# IRF640FP 18A 200V N CHANNEL POWER MOSFET

## Description

## Mechanical Dimensions

IRF640FP

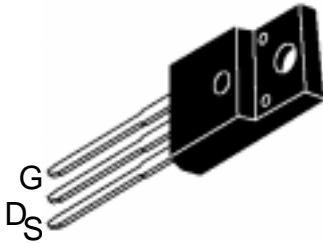

ITO-220AB

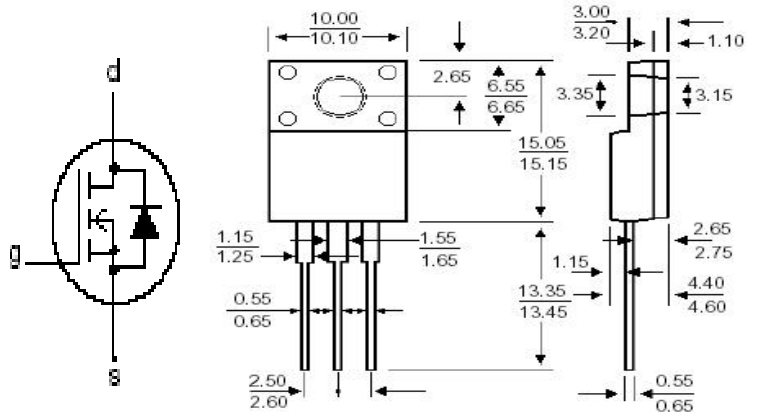

## GENERAL DESCRIPTION

This Power MOSFET is designed for low voltage, high speed power switching applications such as switching regulators, converters, solenoid and relay drivers.

## FEATURES

- ◆ Silicon Gate for Fast Switching Speeds
- ◆ Low  $R_{DS(on)}$  to Minimize On-Losses. Specified at Elevated Temperature
- ◆ Rugged – SOA is Power Dissipation Limited
- ◆ Source-to-Drain Characterized for Use With Inductive Loads

## ABSOLUTE MAXIMUM RATINGS

Rating	Symbol	Value	Unit
Drain to Current – Continuous	$I_D$	18	A
– Pulsed	$I_{DM}$	72	
Gate-to-Source Voltage – Continue	$V_{GS}$	$\pm 20$	V
– Non-repetitive	$V_{GSM}$	$\pm 40$	V
Total Power Dissipation	$P_D$	125	W
Derate above 25°C		1.00	W/°C
Operating and Storage Temperature Range	$T_J, T_{STG}$	-55 to 150	°C
Single Pulse Drain-to-Source Avalanche Energy – $T_J = 25^\circ\text{C}$ ( $V_{DD} = 100\text{V}, V_{GS} = 10\text{V}, I_L = 18\text{A}, L = 1.38\text{mH}, R_G = 25\Omega$ )	$E_{AS}$	224	mJ
Thermal Resistance – Junction to Case	$\theta_{JC}$	1.00	°C/W
– Junction to Ambient	$\theta_{JA}$	62.5	
Maximum Lead Temperature for Soldering Purposes, 1/8" from case for 10 seconds	$T_L$	260	°C

(1) Pulse Width and frequency is limited by  $T_J(\text{max})$  and thermal response



# IRF640FP 18A 200V N CHANNEL POWER MOSFET

## ELECTRICAL CHARACTERISTICS

Unless otherwise specified,  $T_J = 25^\circ\text{C}$ .

Characteristic	Symbol	IRF640			Units
		Min	Typ	Max	
Drain-Source Breakdown Voltage ( $V_{GS} = 0\text{ V}$ , $I_D = 250\ \mu\text{A}$ )	$V_{(BR)DSS}$	200			V
Drain-Source Leakage Current ( $V_{DS} = \text{Rated } V_{DSS}$ , $V_{GS} = 0\text{ V}$ ) ( $V_{DS} = 0.8\text{Rated } V_{DSS}$ , $V_{GS} = 0\text{ V}$ , $T_J = 125^\circ\text{C}$ )	$I_{DSS}$			0.025 1.0	mA
Gate-Source Leakage Current-Forward ( $V_{gsf} = 20\text{ V}$ , $V_{DS} = 0\text{ V}$ )	$I_{GSSF}$			100	nA
Gate-Source Leakage Current-Reverse ( $V_{gsr} = 20\text{ V}$ , $V_{DS} = 0\text{ V}$ )	$I_{GSSR}$			100	nA
Gate Threshold Voltage ( $V_{DS} = V_{GS}$ , $I_D = 250\ \mu\text{A}$ )	$V_{GS(th)}$	2.0		4.0	V
Static Drain-Source On-Resistance ( $V_{GS} = 10\text{ V}$ , $I_D = 10\text{ A}$ ) *	$R_{DS(on)}$			0.18	$\Omega$
Drain-Source On-Voltage ( $V_{GS} = 10\text{ V}$ ) ( $I_D = 5.0\text{ A}$ )	$V_{DS(on)}$			6.0	V
Forward Transconductance ( $V_{DS} = 50\text{ V}$ , $I_D = 10\text{ A}$ ) *	$g_{FS}$	6.8			mhos
Input Capacitance	$(V_{DS} = 25\text{ V}$ , $V_{GS} = 0\text{ V}$ , $f = 1.0\text{ MHz}$ )	$C_{iss}$		1600	pF
Output Capacitance		$C_{oss}$		750	pF
Reverse Transfer Capacitance		$C_{rss}$		300	pF
Turn-On Delay Time	$(V_{DD} = 30\text{ V}$ , $I_D = 10\text{ A}$ , $V_{GS} = 10\text{ V}$ , $R_G = 4.7\Omega$ ) *	$t_{d(on)}$		30	ns
Rise Time		$t_r$		60	ns
Turn-Off Delay Time		$t_{d(off)}$		80	ns
Fall Time		$t_f$		60	ns
Total Gate Charge	$(V_{DS} = 0.8\text{Rated } V_{DSS}$ , $I_D = \text{Rated } I_D$ , $V_{GS} = 10\text{ V}$ ) *	$Q_g$	36	63	nC
Gate-Source Charge		$Q_{gs}$	16		nC
Gate-Drain Charge		$Q_{gd}$	26		nC
Internal Drain Inductance (Measured from the drain lead 0.25" from package to center of die)	$L_D$		4.5		nH
Internal Drain Inductance (Measured from the source lead 0.25" from package to source bond pad)	$L_S$		7.5		nH
<b>SOURCE-DRAIN DIODE CHARACTERISTICS</b>					
Forward On-Voltage(1)	$(I_S = \text{Rated } I_D$ , $dI_S/dt = 100\text{A}/\mu\text{s}$ )	$V_{SD}$		1.5	V
Forward Turn-On Time		$t_{on}$	**		ns
Reverse Recovery Time		$t_{rr}$		450	

\* Pulse Test: Pulse Width  $\leq 300\ \mu\text{s}$ , Duty Cycle  $\leq 2\%$

\*\* Negligible, Dominated by circuit inductance



## TYPICAL ELECTRICAL CHARACTERISTICS

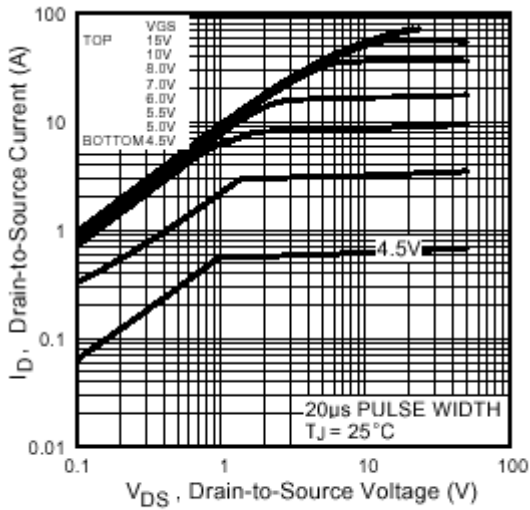

Fig 1. Typical Output Characteristics

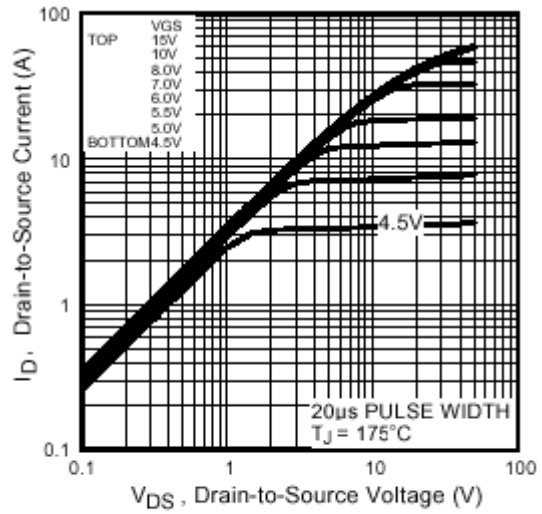

Fig 2. Typical Output Characteristics

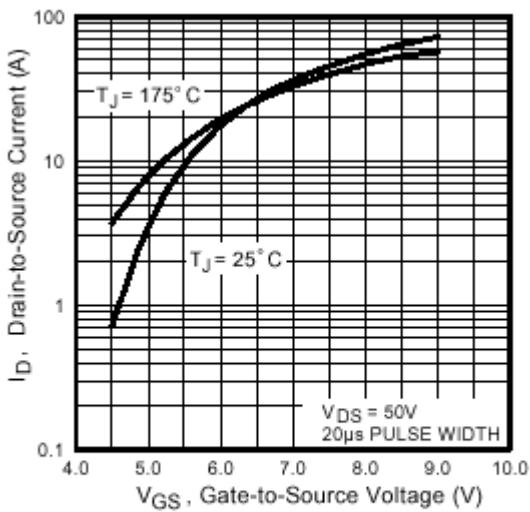

Fig 3. Typical Transfer Characteristics

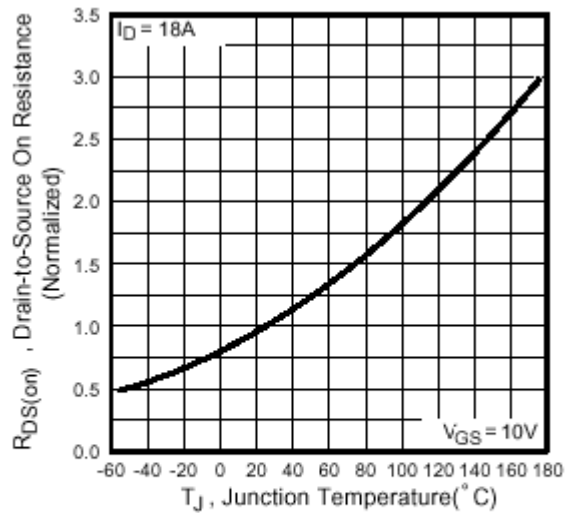
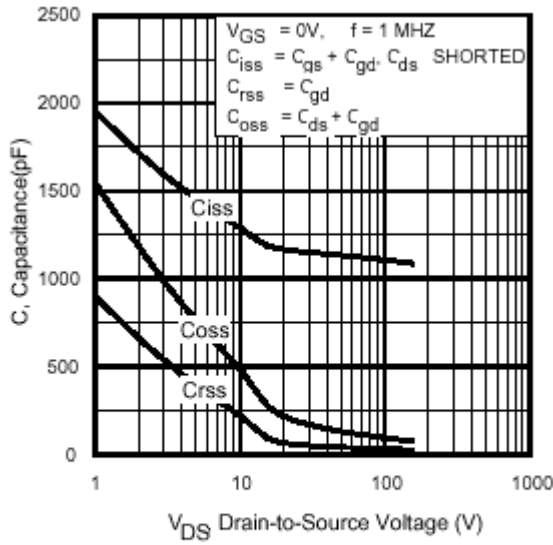

Fig 4. Normalized On-Resistance Vs. Temperature



# IRF640FP 18A 200V N CHANNEL POWER MOSFET



**Fig 5.** Typical Capacitance Vs. Drain-to-Source Voltage

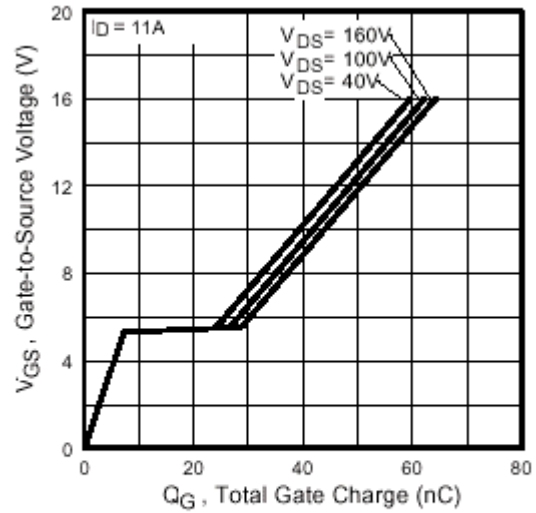

**Fig 6.** Typical Gate Charge Vs. Gate-to-Source Voltage

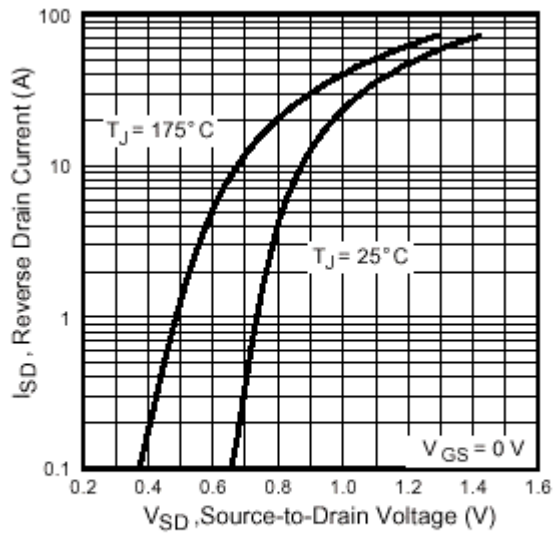

**Fig 7.** Typical Source-Drain Diode Forward Voltage

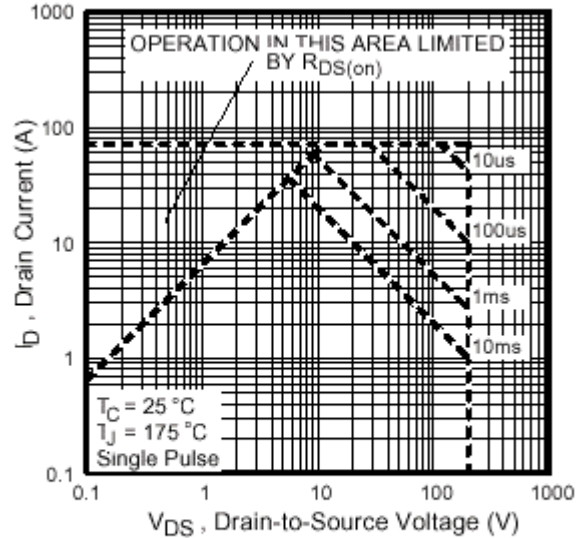

**Fig 8.** Maximum Safe Operating Area



# IRF640FP 18A 200V N CHANNEL POWER MOSFET

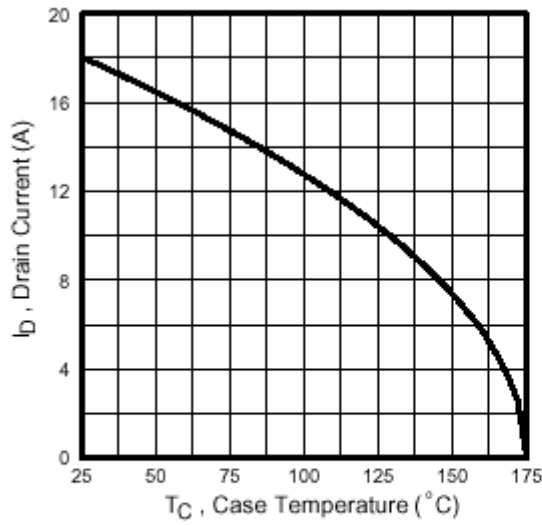

Fig 9. Maximum Drain Current Vs. Case Temperature

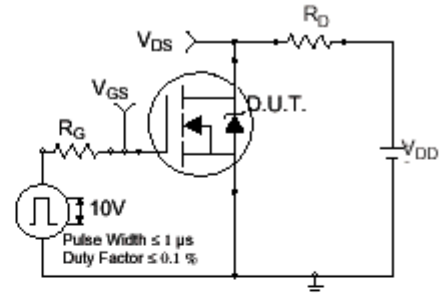

Fig 10a. Switching Time Test Circuit

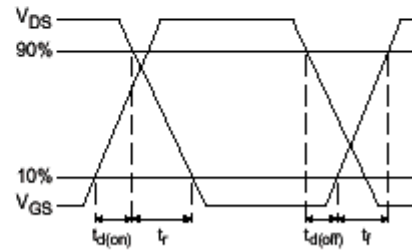

Fig 10b. Switching Time Waveforms

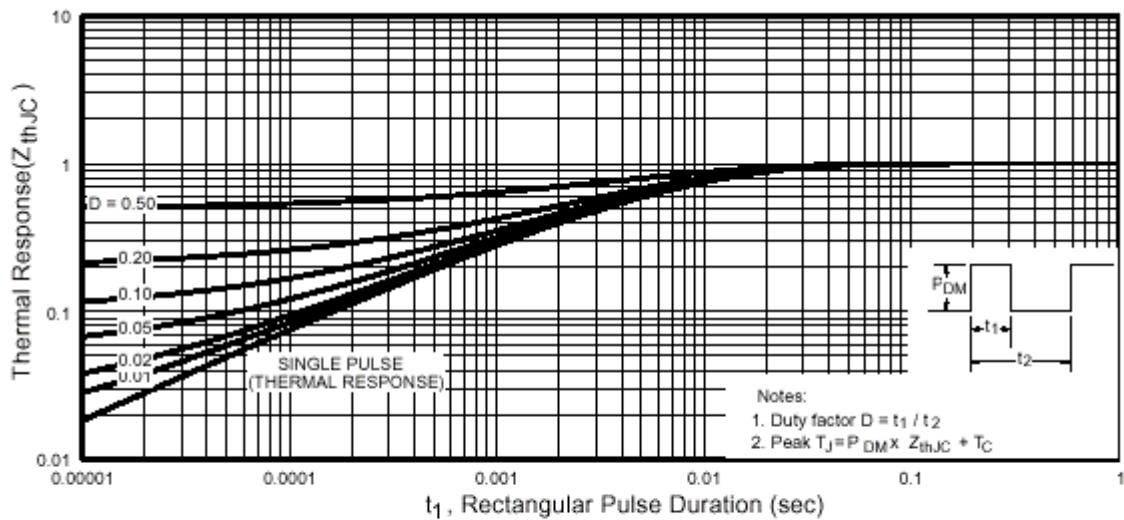

Fig 11. Maximum Effective Transient Thermal Impedance, Junction-to-Case