

SCFR5002~5006

Descriptions



SOZA CELL

Mechanical Dimension

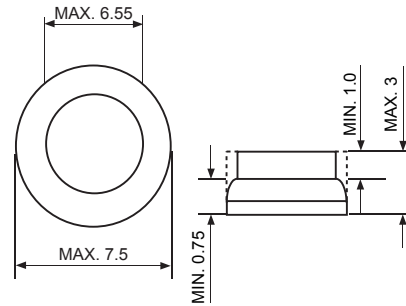

Dimensions in inches and (millimeters)

Features

- ★ Low forward voltage drop
- ★ High current capability
- ★ High reliability
- ★ High surge current capability

Mechanical Data

- ★ Case: OFC Heat Sink
- ★ Encap: Epoxy Sealed Rated
UL94V-0
- ★ Weight: 0.62gram

MAXIMUM RATINGS AND ELECTRICAL CHARACTERISTICS

Rating at 25°C ambient temperature unless otherwise specified.

	SYMBOL	SCFR5002	SCFR5004	SCFR5006	UNIT
Maximum Peak Repetitive Reverse Voltage@Irrm=100mA	VRRM	200	400	600	V
Maximum RMS Voltage	VRMS	140	280	420	V
Maximum DC Blocking Voltage(TA=25°C)	VB	200	400	600	V
Maximum Average Forward Current Io@Tc=150°C 60 Hz, resistive or inductive load	I(AV)	50			A
Peak Forward Surge Current, 8.3ms single Half sine-wave superimposed on rated load (JEDEC method)	IFSM	600			A
Maximum Inst. Forward Voltage Drop, IF at 100Amp	VF	1.2			V
Maximum DC Reverse Current (VB)@TJ=25°C At Rated DC Blocking Voltage (VB)@TJ=150°C	IR	0.5 200			uA uA
Operating Junction and Storage Temperature Range	TJ, TSTG	-65 to +175			°C

RATINGS AND CHARACTERISTIC CURVES SCFR5002 ~SCFR5006

FIG.1 - FORWARD CURRENT DERATING CURVE

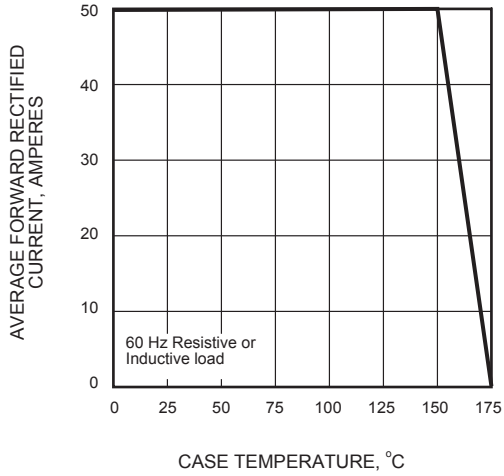

FIG.2 - MAXIMUM NON-REPETITIVE PEAK FORWARD SURGE CURRENT

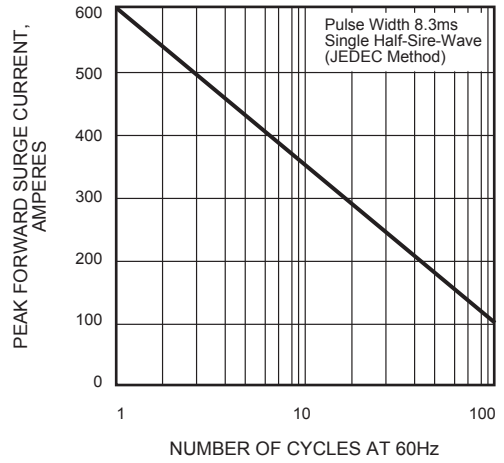

FIG.3 - TYPICAL INSTANTANEOUS FORWARD CHARACTERISTICS

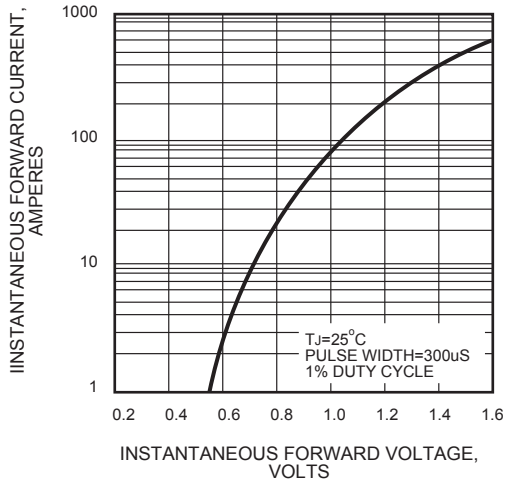

FIG.4 - TYPICAL REVERSE CHARACTERISTICS

